

# OLYMPUS®

<http://www.olympus.com/>

## OLYMPUS IMAGING EUROPA GMBH

Premises: Wendenstrasse 14 – 18, 20097 Hamburg, Germany  
Tel.: +49 40 - 23 77 3-0 / Fax: +49 40 - 23 07 61  
Goods delivery: Bredowstrasse 20, 22113 Hamburg, Germany  
Letters: Postfach 10 49 08, 20034 Hamburg, Germany

### European Technical Customer Support:

Please visit our homepage <http://www.olympus-europa.com>  
or call our TOLL FREE NUMBER\*: **00800 - 67 10 83 00**

for Austria, Belgium, Denmark, Finland, France, Germany, Luxemburg, Netherlands,  
Norway, Portugal, Spain, Sweden, Switzerland, United Kingdom.

\* Please note some (mobile) phone services / provider do not permit access or request an  
additional prefix to +800 numbers.

For all not listed European Countries and in case that you can't get connected  
to the above mentioned number please make use of the following

CHARGED NUMBERS: **+49 180 5 - 67 10 83** or **+49 40 - 237 73 48 99**.

Our Technical Customer Support is available from 9 am to 6 pm MET (Monday to Friday).

### Authorized Distributors

**United Kingdom: Olympus Service Department**    **South Africa: City Square Trading 197 (PTY) Ltd.**  
/ Eire    P.O. Box 222    Unit A, The Meadows  
Southall Middlesex UB2 4SH    Meadowbrooke Business Estate  
Tel.: (0207) 2530513    Jacaranda Avenue, Olivedale Ext. 17  
Johannesburg,  
Tel.: +27 11 7042021

**Egypt:**    **Optoscient M. Nagui & Co**  
10. 26th July St., Cairo  
Tel.: +20 2 391 4883

© 2008 OLYMPUS IMAGING CORP.

Printed in Germany · OIME · 20 · 3/2008 · Hab. · E0460758

E-420

INSTRUCTION MANUAL

OLYMPUS

# OLYMPUS®

## DIGITAL CAMERA

# E-420

# INSTRUCTION MANUAL

**Basic guide**

**P. 2**

Review the camera part names and the  
basic steps for shooting and playback.

**Table of Contents**

**P. 20**

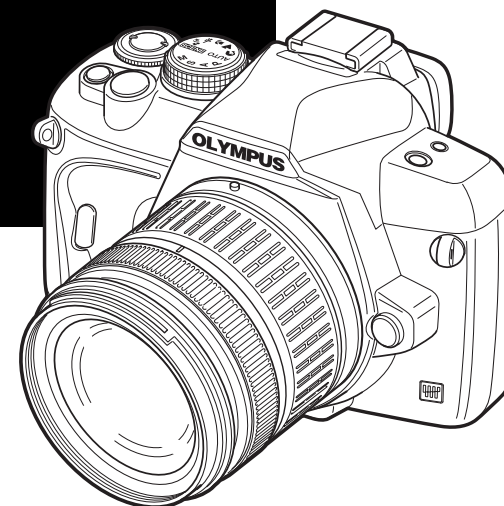

EN

- Before you start to use your new camera, please read the "Safety Precautions" section in this manual.
- We recommend that you take test shots to get accustomed to your camera before taking important photographs.
- The screen and camera illustrations shown in this manual were produced during the development stages and may differ from the actual product.
- The contents in this manual are based on firmware version 1.0 for this camera. If there are addition and/or modification of functions due to firmware update for the camera, the contents will differ. For the latest information, please visit the Olympus website.

# Camera

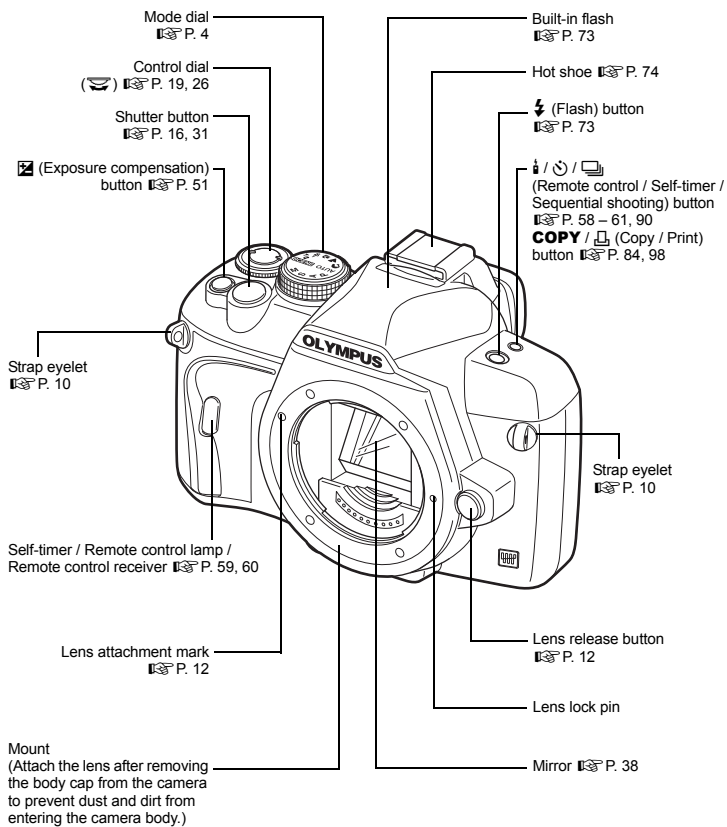

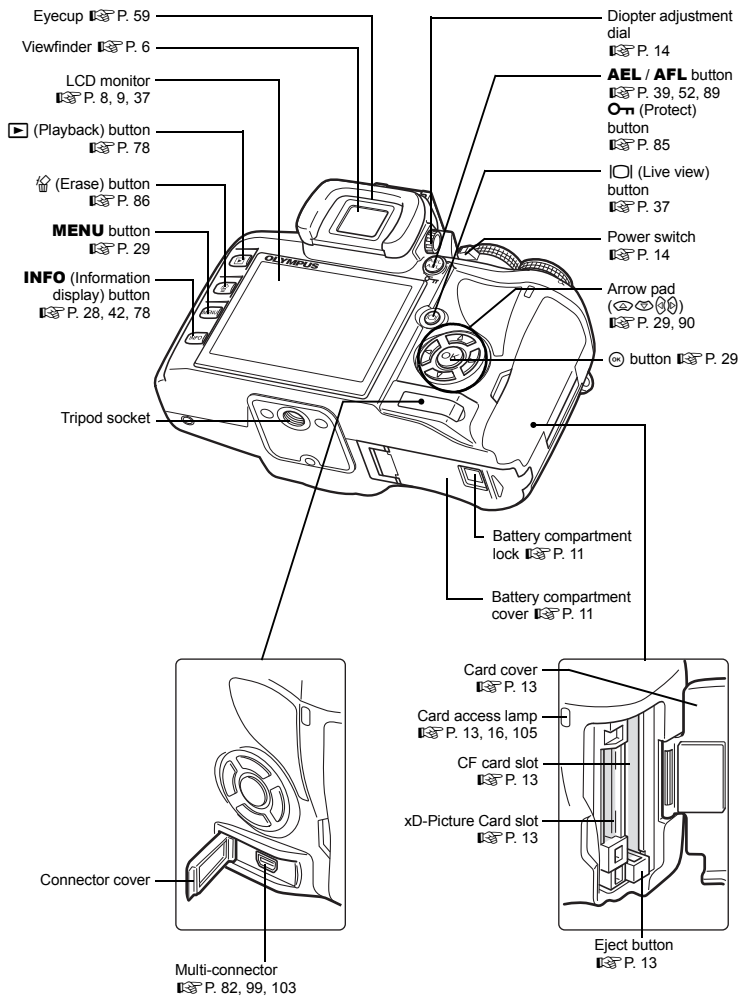

## Mode dial

The mode dial allows you to change the camera settings easily according to the subject.

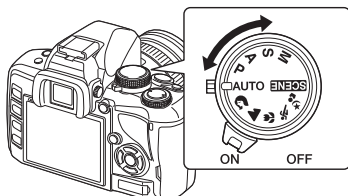







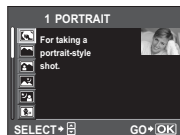











### Easy shooting modes

- Select according to the shooting scene. The camera sets the appropriate shooting conditions automatically.
- When rotating the mode dial or turning off the power in the easy shooting modes, functions with changes made to their settings are restored to the factory default settings.

<b>AUTO</b>	AUTO	Allows you to shoot using an optimum aperture and shutter speed that the camera sets. The built-in flash pops up automatically in low-light conditions.
	PORTRAIT	Suitable for shooting a portrait-style image of a person.
	LANDSCAPE	Suitable for shooting landscapes and other outdoor scenes.
	MACRO	Suitable for taking close-up pictures.
	SPORT	Suitable for capturing fast-moving action without blurring.
	NIGHT+PORTRAIT	Suitable for shooting both the main subject and background at night.
<b>SCENE</b>	Scene mode	<p>When you select a mode to suit the shooting situation, the camera optimizes the settings for the shooting conditions. Unlike the mode dial's scene mode, most functions cannot be changed.</p> <ol style="list-style-type: none"> <li>Set the mode dial to <b>SCENE</b>. <ul style="list-style-type: none"> <li>The scene menu is displayed.</li> </ul> </li> <li>Use   to select the scene mode. <ul style="list-style-type: none"> <li>The sample image followed by a description of the selected mode is displayed.</li> </ul> </li> <li>Press the  button. <ul style="list-style-type: none"> <li>The camera enters the shooting stand-by mode.</li> <li>To change the setting, press the  button again. The scene menu is displayed.</li> </ul> </li> </ol>



## Types of scene modes

Icon		Mode	Icon		Mode
	1	PORTRAIT		10	DIS MODE
	2	LANDSCAPE		11	MACRO
	3	LANDSCAPE+PORTRAIT		12	NATURE MACRO
	4	NIGHT SCENE		13	CANDLE
	5	NIGHT+PORTRAIT		14	SUNSET
	6	CHILDREN		15	FIREWORKS
	7	SPORT		16	DOCUMENTS
	8	HIGH KEY		17	PANORAMA
	9	LOW KEY		18	BEACH & SNOW

## Advanced shooting modes

- For more advanced shooting and greater creative control, you can set the aperture value and shutter speed.
- The settings made in the advanced shooting modes are retained even if the camera is turned off.

<b>P</b>	Program shooting	Allows you to shoot using an aperture and shutter speed that the camera sets. (P. 45)
<b>A</b>	Aperture priority shooting	Allows you to set the aperture manually. The camera sets the shutter speed automatically. (P. 46)
<b>S</b>	Shutter priority shooting	Allows you to set the shutter speed manually. The camera sets the aperture automatically. (P. 47)
<b>M</b>	Manual shooting	Allows you to set the aperture and shutter speed manually. (P. 48)

# Viewfinder

AF target  P. 56

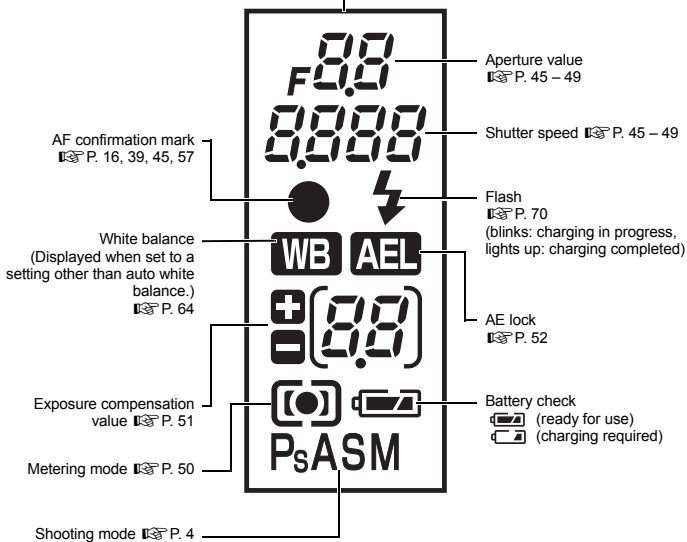
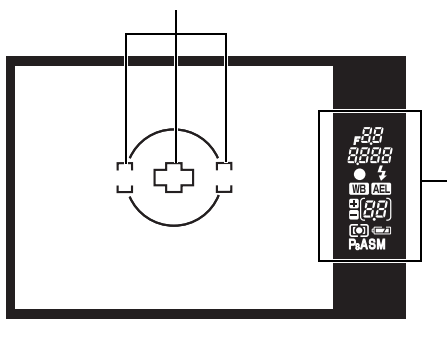

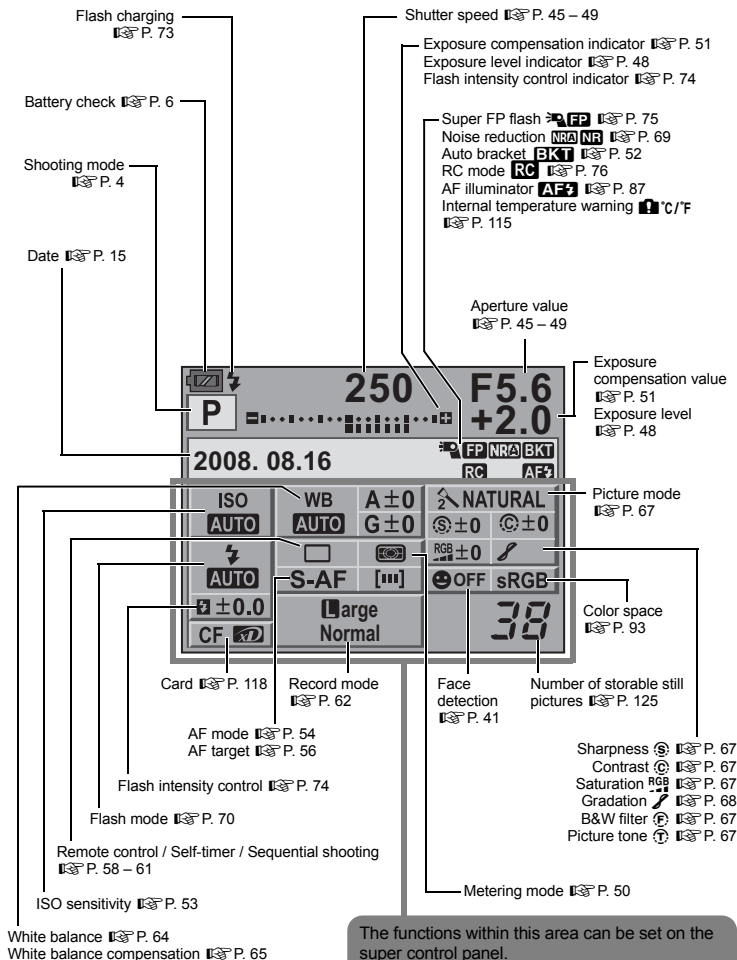

# Super control panel

The following screen allows the display and setting of shooting settings at the same time and is called the super control panel. Press the **INFO** button to display the super control panel on the LCD monitor. "Using the super control panel" (P. 28)



## LCD monitor (Live view)

You can use the LCD monitor to view the subject while shooting. Press the  button to use live view.  "Using live view" (P. 37)

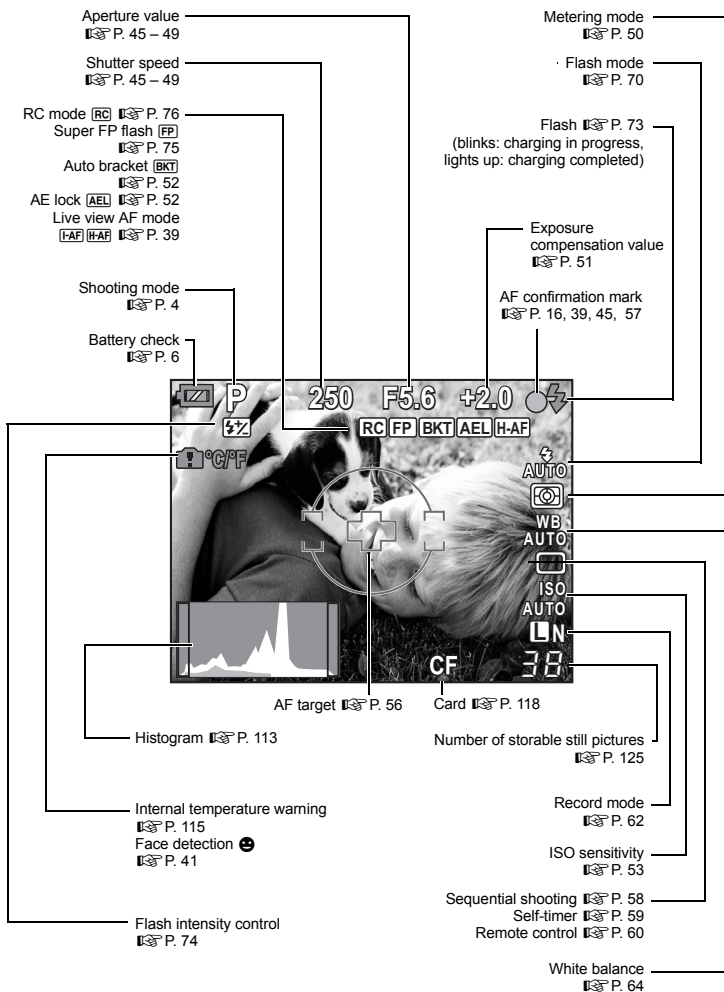



# LCD monitor (Playback)

You can switch the monitor display using the **INFO** button.

☞ "Information display" (P. 80)

Record mode ☞ P. 62

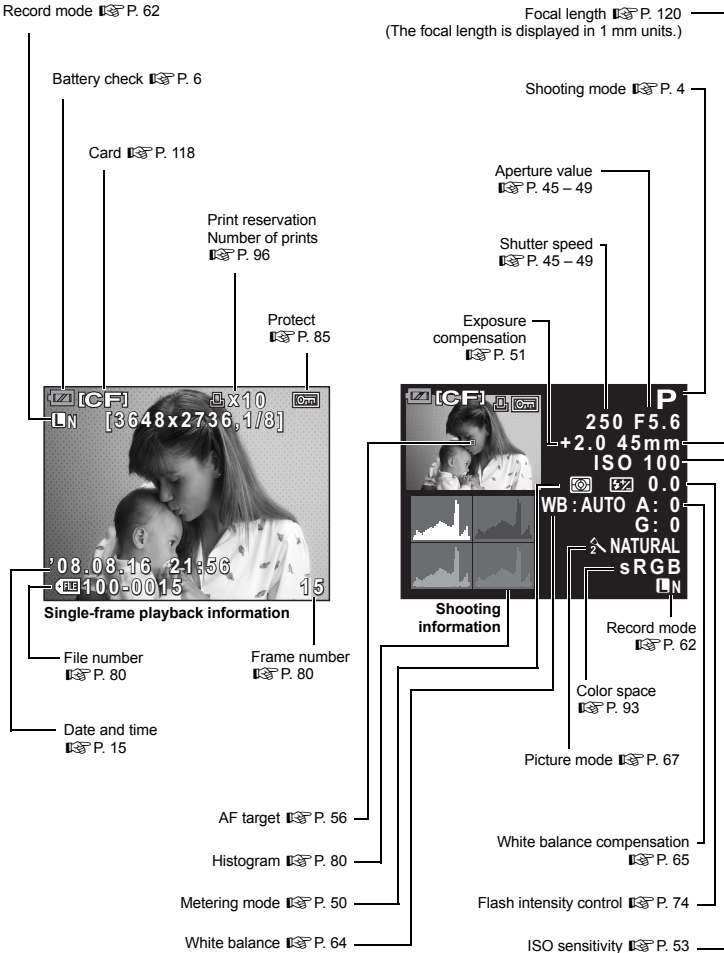

## Unpack the box contents

The following items are included with the camera.  
If anything is missing or damaged, contact the dealer from whom you purchased the camera.



Camera



Body cap



Strap



BLS-1 Lithium ion battery

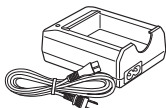

BCS-1 Lithium ion  
charger

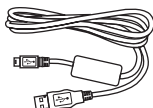

USB cable

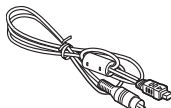

Video cable



OLYMPUS Master 2  
CD-ROM



Instruction manual



Warranty card



Eyepiece cover

### Attaching the strap

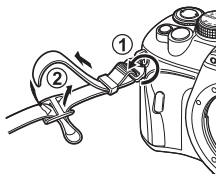

Thread the strap as indicated  
by the arrows (1, 2).

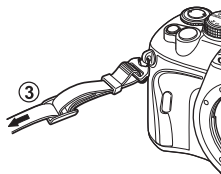

Lastly, pull the strap tight  
making sure that it is fastened  
securely (3).

Attach the other end of  
the strap to the other  
eyelet in the same way.

# Preparing the battery

## 1 Charging the battery

Charging indicator  
Red light: Charging in progress  
Green light: Charging completed  
(Charging time: Approx. 3 hours  
30 minutes)

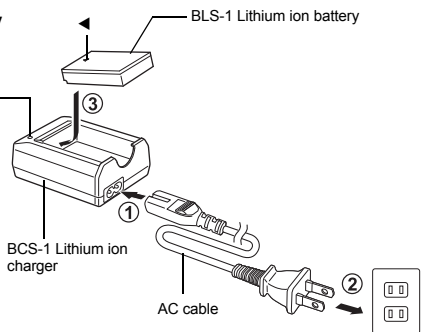

## 2 Loading the battery

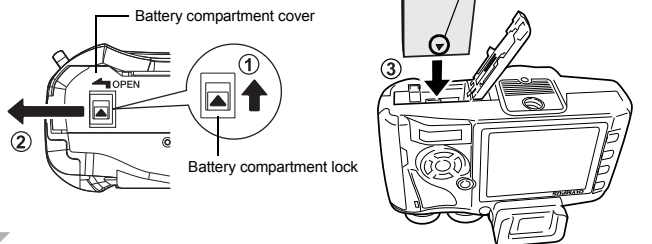

## 3 Close the battery compartment cover

- Close the battery compartment cover until you hear a click.

## Unloading the battery

Press the battery lock to unlock the battery.

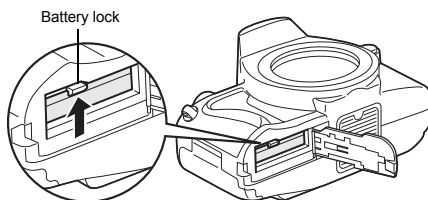

It is recommended to set aside a backup battery for prolonged shooting in case the battery in use drains.

# Attaching a lens to the camera

- 1 Remove the body cap from the camera and the rear cap from the lens

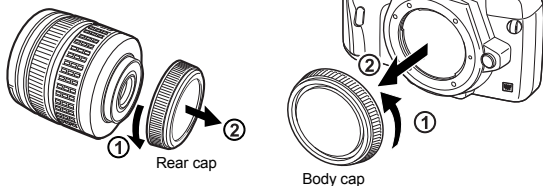

- 2 Attach a lens to the camera

- Align the lens attachment mark (red) on the camera with the alignment mark (red) on the lens, then insert the lens into the camera's body (1).
- Rotate the lens in the direction indicated by the arrow until you hear it click (2).

Do not press the lens release button.

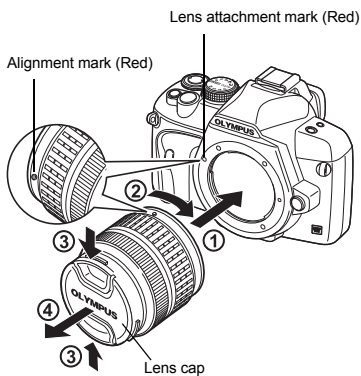

- 3 Remove the lens cap (3, 4)

## Removing the lens from the camera

While pressing the lens release button (1), rotate the lens in the direction of the arrow (2).

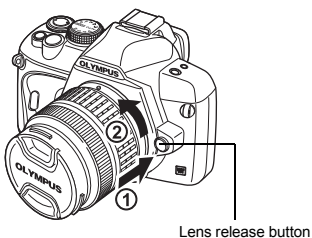

# Loading the card

## CompactFlash / Microdrive

Open the card cover.  
Insert the card's contact area into the slot as far as it can go.

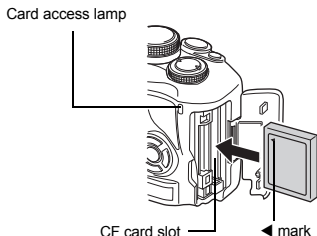

## xD-Picture Card

Open the card cover.  
Insert the card until it is locked into place.

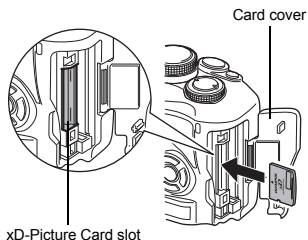

## Removing the card

Never open the card cover while the card access lamp is blinking.

## CompactFlash / Microdrive

- Press the eject button all the way in to make it pop out. Press the eject button again all the way in to eject the card.
- Pull out the card.

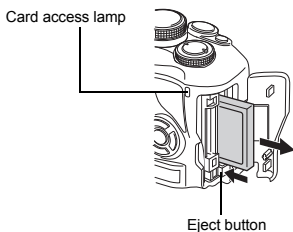

## xD-Picture Card

- Press the inserted card lightly and it will be ejected.
- Pull out the card.

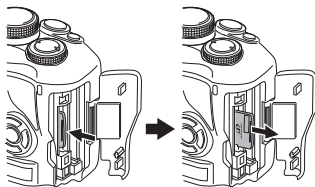

# Power on

## 1 Set the camera's power switch to ON.

- To turn off the power, set the power switch to OFF.

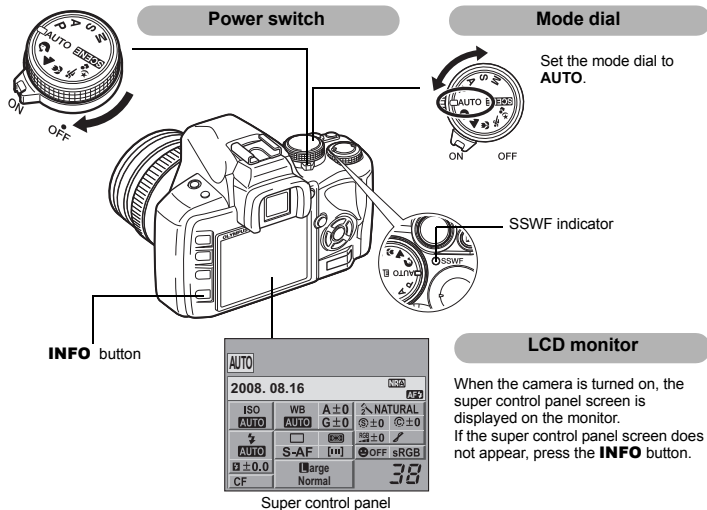

### Dust reduction function operation

The dust reduction function is automatically activated when the camera is turned on. Ultrasonic vibrations are used to remove dust and dirt from the image pickup device's filter surface. The SSWF (Super Sonic Wave Filter) indicator blinks while dust reduction is working.

### Adjusting the viewfinder's diopter

Adjust the viewfinder's diopter in accordance with your vision. While looking through the viewfinder, rotate the diopter adjustment dial little by little. When you can see the AF target clearly, adjustment is complete.

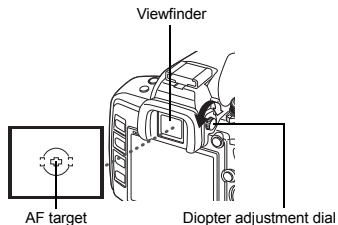

# Setting the date / time

Date and time information is recorded on the card together with the images. The file name is also included with the date and time information. Be sure to set the correct date and time before using the camera.

## 1 Press the **MENU** button

- The menu screen is displayed on the LCD monitor.

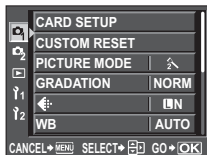

**MENU**  
button

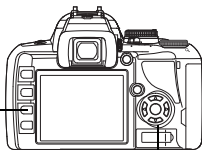

Arrow pad

## 2 Use to select [12], then press

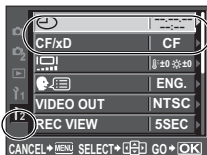

## 3 Use to select [TIME], then press

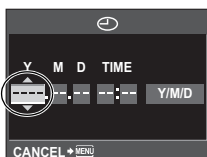

## 4 Use to select [Y], then press

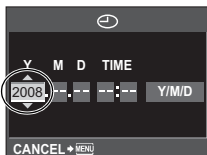

## 5 Repeat this procedure until the date and time are completely set



- The time is displayed in the 24-hour format.

## 6 Use to select the date format

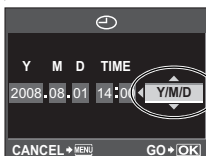

## 7 Press the button



## 8 Press the **MENU** button to exit

# Shooting

- 1 Place the AF target on the subject while viewing through the viewfinder

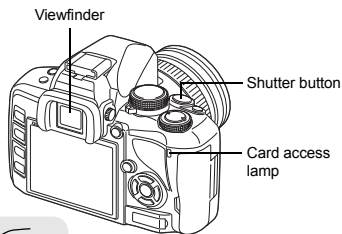

- 2 Adjust the focus

Press the shutter button halfway.

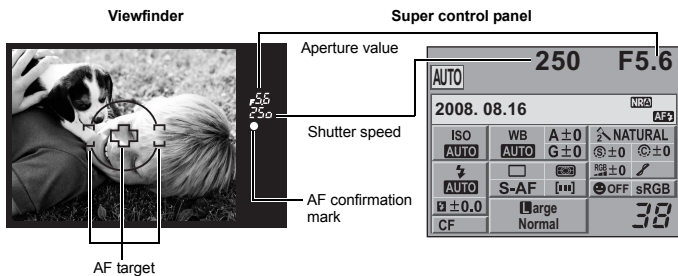

- The focus is locked when a beep tone is output. The AF confirmation mark and the AF target in focus light up in the viewfinder.
- The shutter speed and aperture value that have been set automatically by the camera are displayed.
- The super control panel is not displayed while the shutter button is pressed.

- 3 Release the shutter

Press the shutter button all the way (fully).



- The shutter sounds and the picture is taken.
- The card access lamp blinks and the camera starts recording the picture.

Never remove the battery or card while the card access lamp is blinking. Doing so could destroy stored pictures and prevent storage of pictures you have just taken.



## Holding the camera

Keep your fingers and the strap away from the lens and flash.



Horizontal grip

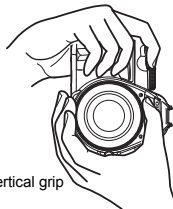

Vertical grip

## Taking a picture while viewing the monitor

It is possible to use the LCD monitor as a viewfinder and check the subject's composition, or shoot while viewing an enlarged display on the LCD monitor. "Using live view" (P. 37)

### 1 Press the (live view) button to switch to live view

- The subject is displayed on the LCD monitor.

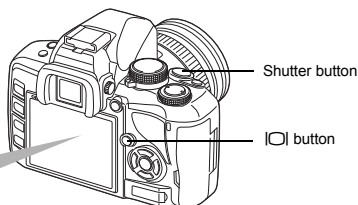

### 2 Press the shutter button to take the picture

- The picture is taken with the focus adjusted.

## When the camera stops operating

If no operations are performed for approximately 8 seconds while the camera is on, the monitor backlight turns off to save battery power (when the super control panel is lit). If no operations are performed for approximately one minute thereafter, the camera enters the sleep mode (stand-by) and stops operating. The camera activates again when you touch any button (the shutter button, button, etc.).

"BACKLIT LCD (Backlight timer)" (P. 91), "SLEEP" (P. 90)

## Playback / Erasing

### Playing back images

Pressing the  button displays the last picture taken.

 button

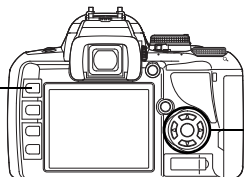

Arrow pad

Displays the frame that is stored  
10 frames back

Displays the previous  
frame



Displays the  
next frame

Displays the frame that is stored  
10 frames ahead

### Close-up playback

Each time you turn the control dial towards , the image is incrementally enlarged from 2x to 14x.

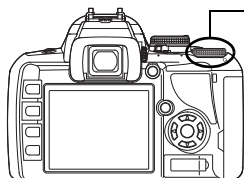

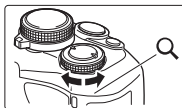

Control dial



### Erasing images

Play back the image you want to erase and press the  button.

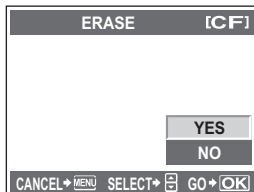
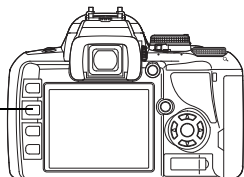

Use   to select **[YES]** and press the  button to erase.

 button



# Indications used in this manual

- The operation button icons on the body of the camera are used to indicate the operation buttons in this manual. See “Names of parts and functions” (📖 P. 2).
- In this manual, 🔄 indicates the control dial.
- The following symbols are used throughout this manual.

 <b>Notes</b>	Important information on factors which may lead to a malfunction or operational problems. Also warns of operations that should be absolutely avoided.
 <b>TIPS</b>	Useful information and hints that will help you get the most out of your camera.
	Reference pages describing details or related information.

## To make the most of this manual

You can use the “Table of Contents” (P. 20) or “Index” (P. 145) as well as the following reference to search for information on camera functions and operations. Use this manual according to shooting conditions and to find the desired information.

For information on the possible shooting functions:

📖 “Shooting guides” (P. 31)

For information on how to operate the camera:

📖 “Using the direct buttons” (P. 27)

“Using the super control panel” (P. 28)

“Using the menu” (P. 29)

Functions available during live view:

📖 “Using live view” (P. 37)

To search for a function from a list:

📖 “Menu directory” (P. 127)

“Index” (P. 145)

# Table of Contents

## Basic guide

2

Identifies the camera part names and describes the basic steps for shooting and playback.

Names of parts and functions .....	2
Camera .....	2
Mode dial .....	4
Viewfinder .....	6
Super control panel .....	7
LCD monitor (Live view) .....	8
LCD monitor (Playback) .....	9
Unpack the box contents .....	10
Preparations for shooting .....	11
Preparing the battery .....	11
Attaching a lens to the camera .....	12
Loading the card .....	13
Power on .....	14
Setting the date / time .....	15
Shooting .....	16
Playback / Erasing .....	18
Indications used in this manual .....	19

## 1 Basic camera operations

26

Describes the basic operations of the camera.

Using the direct buttons .....	27
Using the super control panel .....	28
Using the menu .....	29
Resetting to the factory default settings .....	30

## 2 Shooting guides – Improving your shooting skills

31

Describes shooting methods for various shooting situations.

Basic function guides .....	31
Focus – Operating the shutter button .....	31
Brightness – Exposure compensation .....	32
Color – White balance .....	32
A guide to functions for different subjects .....	33
Taking landscape pictures .....	33
Taking flower pictures .....	34
Taking night scene pictures .....	35

### 3 Using live view

37

Functions and operations available only during live view will be explained.

Activating live view.....	37
Functions available during live view.....	37
The live view mechanism.....	38
Taking a picture using live view.....	39
AF operation during live view.....	40
Using the face detection function.....	41
Taking a picture using manual focus.....	42
Switching the information display.....	42
Taking a picture while comparing the effect.....	43
Enlarged display operation.....	43
Panorama shooting.....	44

### 4 Exposure

45

Describes functions related to exposure, which is important for shooting. These functions are for determining the aperture value, shutter speed, and other settings by measuring the brightness in the picture.

Program shooting.....	45
Aperture priority shooting.....	46
Shutter priority shooting.....	47
Manual shooting.....	48
Bulb shooting.....	49
Preview function.....	49
Changing the metering mode.....	50
Exposure compensation.....	51
AE lock.....	52
AE bracketing.....	52
ISO sensitivity setting.....	53

### 5 Focusing and shooting functions

54

Describes the optimal focusing methods according to the subject and shooting conditions.

AF mode selection.....	54
S-AF (single AF).....	54
C-AF (continuous AF).....	55
MF (manual focus).....	55
Simultaneous use of S-AF mode and MF mode (S-AF+MF).....	55
Simultaneous use of C-AF mode and MF mode (C-AF+MF).....	56
AF target selection.....	56
Focus lock – If correct focus cannot be obtained.....	57
Sequential shooting.....	58
Self-timer shooting.....	59
Remote control shooting.....	60
Anti-shock.....	61

## **6 Record mode, white balance, and picture mode**

**62**

Describes image adjustment functions specific to digital cameras.

Selecting the record mode .....	62
Recording formats .....	62
Selecting the record mode .....	63
Selecting the white balance .....	64
Setting the auto / preset / custom white balance .....	65
WB compensation .....	65
Setting the one-touch white balance .....	66
Picture mode .....	67
Gradation .....	68
Noise reduction .....	69
Noise filter .....	69

## **7 Flash shooting**

**70**

Describes how to shoot with the built-in flash and an external flash.

Flash mode setting .....	70
Built-in flash shooting .....	73
Flash intensity control .....	74
External flash shooting .....	74
Shooting with the Olympus wireless RC flash system .....	76
Using commercially available flashes .....	77















## **8 Playback functions**

**78**

Describes the functions for image playback.

Single-frame / Close-up playback .....	78
Index display / Calendar display .....	79
Information display .....	80
Slideshow .....	81
Rotating images .....	81
Playback on TV .....	82
Editing still images .....	82
Copying images .....	84
Protecting images .....	85
Erasing images .....	86

Describes how to customize the camera's settings.

Custom Menu 1.....	87
<b>iA</b> AF / MF .....	87
AF ILLUMINAT.....	87
FOCUS RING.....	87
RESET LENS.....	87
BULB FOCUSING.....	87
<b>iB</b> BUTTON / DIAL .....	88
DIAL FUNCTION.....	88
DIAL DIRECTION .....	88
AEL / AFL.....	89
AEL / AFL MEMO.....	89
 FUNCTION.....	90
 FUNCTION.....	90
<b>iC</b> DISP /  / PC.....	90
 .....	90
SLEEP.....	90
BACKLIT LCD (Backlight timer).....	91
USB MODE.....	91
LIVE VIEW BOOST.....	91
 FACE DETECT.....	91
FRAME ASSIST (Ruled lines display) .....	92
<b>iD</b> EXP /  / ISO .....	92
ISO-AUTO SET.....	92
ISO-AUTO.....	92
AEL Metering.....	92
BULB TIMER.....	92
<b>iE</b>  CUSTOM.....	92
 +  .....	92
AUTO POP UP.....	92
<b>iF</b>  / COLOR / WB.....	93
ALL  .....	93
COLOR SPACE.....	93
 SET .....	93
PIXEL COUNT .....	93
<b>iG</b> RECORD / ERASE .....	93
RAW+JPEG ERASE .....	93
FILE NAME.....	94
dpi SETTING.....	94
Custom Menu 2.....	94
CF / xD .....	94
 (Monitor brightness adjustment).....	95
 (Changing the display language).....	95
VIDEO OUT .....	95
REC VIEW .....	95
FIRMWARE.....	95

## 10 Printing

96

Describes how to print your pictures.

Print reservation (DPOF) .....	96
Print reservation .....	96
Single-frame reservation .....	96
All-frame reservation .....	97
Resetting the print reservation data .....	98
Direct printing (PictBridge) .....	98
Connecting the camera to a printer .....	99
Easy printing .....	99
Custom printing .....	100

## 11 Using the OLYMPUS Master software

102

Describes how to transfer and store your camera images to a computer.

Flowchart .....	102
Using the provided OLYMPUS Master software .....	102
What is OLYMPUS Master? .....	102
Connecting the camera to a computer .....	103
Start up the OLYMPUS Master software .....	104
Displaying camera images on a computer .....	104
Downloading and saving images .....	104
Disconnecting the camera from your computer .....	105
Viewing still images .....	106
To increase the number of languages .....	106
Transferring images to your computer without using OLYMPUS Master .....	107

## 12 Shooting tips and maintenance

108

Refer to this section for troubleshooting and camera maintenance information.

Shooting tips and information .....	108
Tips before you start taking pictures .....	108
Shooting tips .....	109
Additional shooting tips and information .....	111
Playback tips .....	113
Viewing pictures on a computer .....	113
Error codes .....	114
Camera maintenance .....	116
Cleaning and storing the camera .....	116
Cleaning mode – Removing dust .....	117
Pixel mapping – Checking the image processing functions .....	117



Refer to this section for information on optional accessories, camera specifications, and other useful shooting information.

Card basics .....	118
Usable cards .....	118
Formatting the card .....	118
Battery and charger .....	119
Using your charger abroad .....	119
Interchangeable lenses .....	119
ZUIKO DIGITAL interchangeable lens .....	120
ZUIKO DIGITAL lens specifications .....	120
Program line diagram ( <b>P</b> mode) .....	122
Exposure warning display .....	123
Flash modes that can be set by shooting mode .....	124
White balance color temperature .....	125
Record mode and file size / number of storable still pictures .....	125
Functions that can be registered in Custom Reset Settings .....	126
Menu directory .....	127
Glossary .....	130
Specifications .....	133
E-System Chart .....	136
SAFETY PRECAUTIONS .....	138
Index .....	145

# 1 Basic camera operations

There are three basic ways to make function settings with this camera.

## 1 Using the direct buttons to operate the camera P. 27

You can make the function settings by rotating the control dial while pressing the direct buttons assigned to a function.

## 2 Setting while looking at the super control panel P. 28

You can make the function settings with the super control panel on the LCD monitor. You can use the super control panel to view the current settings and directly change the settings.

## 3 Setting on the menu P. 29

You can use the menu to set shooting and playback settings and customize camera functions.

Basic camera operations

### Descriptions in this manual

---

The operating instructions of the direct buttons, super control panel and menu are described as follows in this manual.

- “+” indicates operations performed at the same time.
- “▶” indicates you should proceed to the next step.

e.g.: When setting the flash intensity control

**Direct button**



**Super control panel**



**Menu**



## Using the direct buttons

### 1 Press the button for the function you want to set.

- The direct menu is displayed.

e.g.) Setting Sequential / Self-timer / Remote control shooting

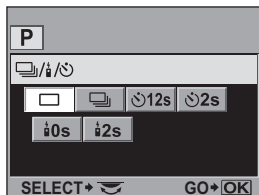

Direct menu

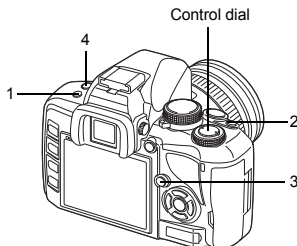

### 2 Turn the control dial to change the setting.

- Press the  $\odot$  button to confirm your setting. Or if you do not operate the control dial within a few seconds, your setting will be confirmed and the super control panel screen will be restored.

### List of direct buttons

The functions assigned to buttons are as shown below.

No.	Direct buttons	Function	Ref. page
1	Remote control / Self-timer / Sequential shooting button	Remote control / Self-timer / Sequential shooting	P. 58 – 61
2	Exposure compensation button	Exposure compensation	P. 51
3	Live view button	Turns live view on or off	P. 37
4	Flash button	Pops up the flash and sets flash mode	P. 70
2 +	Exposure compensation button	Flash intensity control	P. 74
4	Flash button		

### TIPS

To assign other functions so they can be set with direct buttons:

→ You can also assign frequently used functions to the  $\odot$  and buttons.

"FUNCTION" (P. 90), "FUNCTION" (P. 90)

# Using the super control panel

Select an item on the super control panel and change the setting.

## 1 Press the **INFO** button to display the super control panel on the LCD monitor.

- Press the **INFO** button again to turn off the super control panel.
- Press the **INFO** button during live view to display the super control panel.

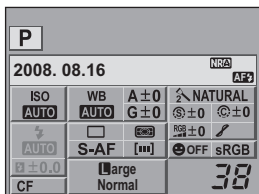
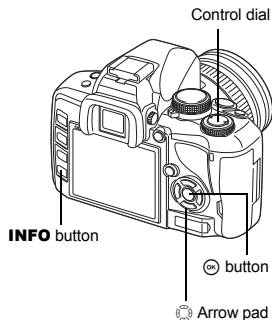

## 2 Press the **INFO** button.

- The cursor on the super control panel lights.

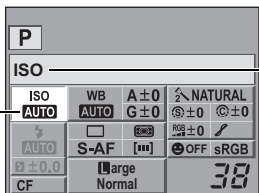

Cursor

The name of the selected function is displayed.

## 3 Use the **INFO** button to move the cursor to the function you want to set.

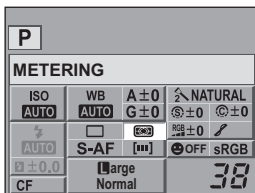

## 4 Use the control dial to change the setting.

- Press the **INFO** button to display the direct menu indicated at the position of the cursor. You can also use the direct menu to change the setting. After changing the setting, press the **INFO** button to confirm your setting. If no operation is made within a few seconds, your setting is confirmed and the super control panel is displayed.

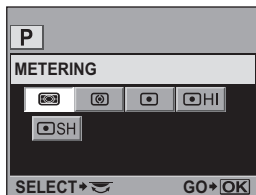

Direct menu

For details on the functions that can be set with the super control panel, refer to "Super control panel" (P. 7).

# Using the menu

- 1 Press the MENU button.**
- The menu is displayed on the LCD monitor.

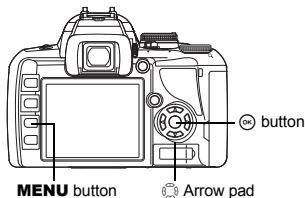
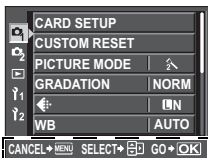

Operation guide is displayed at the bottom of the screen.

**CANCEL** : Press the **MENU** button to cancel the setting.

**SELECT** : Press on the arrow pad to move the cursor and select an item.  
The symbols displayed on the LCD monitor correspond to the arrow pad shown below.

: Press the button to confirm your settings.

- 2 Use to select a tab and to set an item.**
- 3 Use to select a function and to go to the setting screen.**

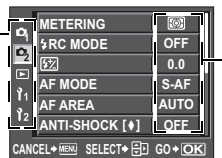

Tab

The current setting is displayed

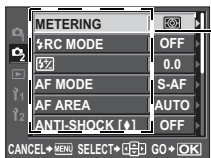

Function

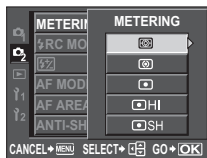

## Types of tabs

- (Shooting menu 1)  
Sets shooting functions.
- (Shooting menu 2)  
Sets shooting functions.
- (Playback menu)  
Sets playback functions.
- (Custom menu 1)  
Customizes shooting functions. Depending on the function being customized, the function is further separated into 8 tabs (A to H).
- (Custom menu 2)  
Sets the basic functions of the camera.

Screenshot of menu with the tab selected

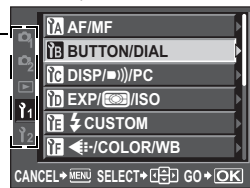

Tab

- 4 Press the OK button to confirm your settings.**
- Press the OK button repeatedly to exit the menu.

For details on the functions that can be set with the menu, refer to “Menu directory” (P. 127).

1

Basic camera operations

## Resetting to the factory default settings

Normally, current camera settings (including any changes you have made) are retained when the power is turned off. To reset the camera to the factory default settings, set **[RESET]**. You can register settings in advance to **[RESET1]** and **[RESET2]**. The camera settings at that time are registered in **[RESET1]** and **[RESET2]**. For details on the registered functions, refer to "Functions that can be registered in Custom Reset Settings" (P. 126).



1

Basic camera operations

### Registering **[RESET1]** / **[RESET2]**

Menu

MENU ▶ [F4] ▶ [CUSTOM RESET]

- 1 Select either **[RESET1]** / **[RESET2]** to register and press 
  - If settings have already been registered, **[SET]** is displayed next to **[RESET1]** / **[RESET2]**. Selecting **[SET]** again overwrites the registered setting.
  - To cancel the registration, select **[RESET]**.
- 2 Select **[SET]** and press the  button.

### Using reset settings





You can reset the camera to **[RESET1]** or **[RESET2]** setting or restore the factory default settings.

**[RESET]** : Resets to the factory default settings. For the default settings, see "Menu directory" (P. 127).

**[RESET1]** / **[RESET2]** : Resets to the registered settings.

Menu

MENU ▶ [F4] ▶ [CUSTOM RESET]

- 1 Select **[RESET]**, **[RESET1]**, or **[RESET2]** and press the  button.
- 2 Use   to select **[YES]**, then press the  button.

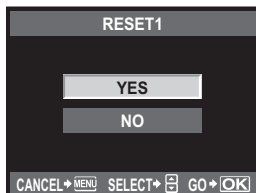

## Basic function guides

To familiarize yourself with the camera, you can start off by taking pictures of surrounding subjects, such as children, flowers and pets. If the pictures taken are not to your liking, try adjusting some of the settings below. You can take more satisfying pictures simply by familiarizing yourself with these basic camera functions.

### Focus – Operating the shutter button

A picture can become out of focus when the focus in the picture is on the foreground, background, or other objects in the picture instead of on the subject. To prevent out-of-focus pictures, be sure to focus on the subject you are trying to capture. The shutter button can be pressed halfway down (half-press) and all the way down (full press). Once you are able to operate the shutter button effectively, you can focus accurately even on moving subjects.



- 🔍 “Shooting” (P. 16), “Focus lock – If correct focus cannot be obtained” (P. 57)

Even when the subject is in focus, the picture can become blurred if you move the camera while the shutter button is being pressed. This is called “camera shake”. Make sure how to properly hold the camera. The camera is particularly subject to shaking when using live view to take pictures while viewing the subject on the monitor.

- 🔍 “Holding the camera” (P. 17)

In addition to incorrect focusing and camera shake, movement of the subject can also cause blurring of the picture. In this case, use a shutter speed that matches the motion of the subject. You can confirm the actual shutter speed and aperture on the displays of the viewfinder and monitor by pressing the shutter button halfway.

- 🔍 “Viewfinder” (P. 6), “Super control panel” (P. 7), “LCD monitor (Live view)” (P. 8)



## Brightness – Exposure compensation

The camera automatically determines the aperture value and shutter speed according to the brightness level. This is called auto exposure. However, you may not be able to capture the intended picture with auto exposure alone. In this case, you can increase or decrease the auto exposure setting.

Compensate the exposure toward + to enhance the brightness of a summer beach or the whiteness of snow. Compensate the exposure toward – when the area to be shot is brighter but smaller compared to its surrounding area.

If you are unsure of how much exposure compensation is required, try taking several pictures at various settings and then compare the pictures.



☞ “Exposure compensation” (P. 51), “AE bracketing” (P. 52)

2

Shooting guides – Improving your shooting skills

## Color – White balance

Besides sunlight, there are other sources for illuminating the subject, such as tungsten and fluorescent lighting. These types of lighting contain particular colors; therefore, the same white object shot under different lighting has slightly different colors. Even under the same sunlight, the colors in the picture differ depending on the sky conditions, the shadows of trees or buildings, and other factors. White balance automatically corrects the effects from these types of lighting and enables shooting with the right colors. You can usually obtain the right colors with the white balance set to **[AUTO]**. Depending on the shooting conditions, however, you may not be able to obtain the intended colors. In this case, change the setting accordingly.

☞ “Selecting the white balance” (P. 64)

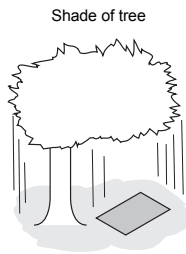
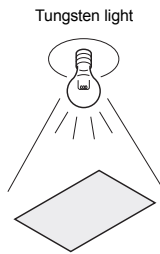
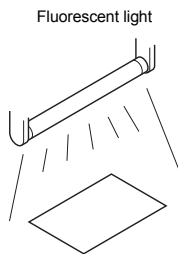



## A guide to functions for different subjects

This section describes the functions suitable under different shooting conditions depending on the subject.

### Taking landscape pictures

This section describes how to take outdoor scenery pictures of forests, lakes and beaches in daylight.

#### Changing shooting mode

The proper shooting method varies depending on whether you are trying to capture the silence of a still scene or the dynamism of a motion scene.

- To capture the depth of a forest, focus with a wider range of the image. Use **A** (aperture priority shooting) mode and close the aperture (increase the aperture value) as much as possible.
- To capture the waves crashing against the seashore, use **S** (shutter priority shooting) mode and select a fast shutter speed. To capture a flowing waterfall or river, shoot using a slow shutter speed.

Exposure compensation can be used even under different shooting modes. Check the image that you have shot and use + or – to adjust the exposure to obtain better results.

#### Changing white balance

The color of water in pictures appears different depending on whether it is a lake reflecting nearby trees or a seashore surrounded by a coral reef. To capture the subtle difference in color, try changing the white balance setting. Change the setting for different situations, such as by using [☀️] **5300 K** for sunny days and [🏠] **7500 K** for outdoor shaded areas on sunny days.

#### Changing metering mode

Depending on the depth of the water and the direction of the sun, the brightness of the water can differ significantly in different areas of the same composition. There is also a difference in the brightness of forests depending on the way the trees overlap each other. If you know which areas you want to emphasize the compensation in the image composition, you can change the metering mode. When set to [☰] (Digital ESP metering), the camera automatically assesses the brightness in the composition and determines the exposure. To emphasize a specific partial exposure in the composition, change the metering mode to [⊙] (center weighted metering) or [□] (spot metering), adjust the metering area to the locations that you want to adjust the exposure and then measure the exposure.

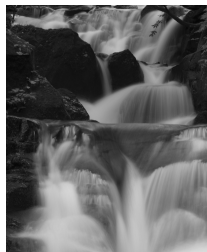

## Changing saturation

There may be times when you cannot reproduce the desired color even when using white balance or exposure compensation. In this case, you can change the **[SATURATION]** setting to achieve the desired color. The **[SATURATION]** setting includes two levels of high and low settings. When the setting is high, a vivid color is used.

🔍 “Aperture priority shooting” (P. 46), “Shutter priority shooting” (P. 47), “Changing the metering mode” (P. 50), “Exposure compensation” (P. 51), “Selecting the white balance” (P. 64), “[SATURATION] : Vividness of the color.” (P. 67)

## Taking flower pictures

The proper method for taking pictures of flowers differs depending on whether you want to capture, for example, a single flower, a field of blooming flowers, a deep red rose, or the light color of a sweet pea.

### Changing white balance

There are many colors of flowers ranging from light to vivid ones. Depending on the colors of the flowers, subtle color shades may not be captured as seen. In this case, you can check the light conditions and change the white balance setting. At **[AUTO]**, the camera automatically determines the type of light and shoots using the proper white balance. However, you can bring out subtle color shades more effectively by changing the setting according to shooting conditions, such as by using **[☀️ 5300 K]** for sunny days and **[🏠 7500 K]** for outdoor shaded areas on sunny days.



### Using exposure compensation

When shooting flowers against a background, select as simple a background as possible to bring out the shape and color of the flower. When shooting bright and whitish flowers, adjust the exposure compensation to – (minus) so that the flower stands out from the darker background.

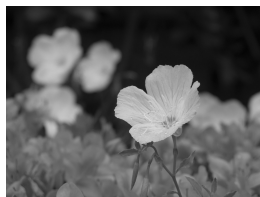

## Changing shooting mode

The proper shooting method when taking pictures of flowers differs depending on whether you want to emphasize a single flower or capture a field of flowers. To change the focus area, set the camera to **A** (aperture priority shooting) mode and select the aperture value.

- When you open the aperture (decrease the aperture value), the camera focuses within a shorter range (with a shallow depth of field), emphasizing the subject against a blurred background.
- When you close the aperture (increase the aperture value), the camera focuses over a wider range (with more depth of field), producing a picture with both the foreground and background in focus.

You can use the preview function to confirm the changes in the depth of field when the aperture is changed.



## Using live view

When using a conventional digital single-lens reflex camera with interchangeable lens system, it was necessary to wait until after taking the picture to check the results of the exposure compensation and white balance settings. With the live view function of this camera, however, you can use the monitor to display and check the subject you want to capture.

## Changing lenses

When the blooming flowers are few and sparse, take the picture using a telephoto lens. With a telephoto lens, you take pictures in which subjects at different distances appear closer together, giving the impression of a more densely blooming flower field. Using the telescopic feature of the zoom lens also achieves the same effect, but it is easier to achieve this effect when the focal length of the lens is longer, such as 150 mm or 200 mm, rather than 54 mm.

☞ “Aperture priority shooting” (P. 46), “Using live view” (P. 37), “Exposure compensation” (P. 51), “Selecting the white balance” (P. 64)

## Taking night scene pictures

There are different types of night scenes, from the afterglow of a sunset and city lights at night to special light displays and firework displays.

## Using a tripod

Because a slow shutter speed is needed to capture night scenes, a tripod is required to prevent camera shake. If a tripod is not available, you should place the camera on a stable surface to prevent camera shake. Even if the camera is secured, camera shake may occur when pressing the shutter button. Therefore, it is recommended to use the remote control or self timer.

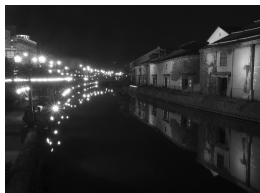

## Changing shooting mode

Night scenes have different levels of brightness, and the balance of the brightness in the composition is not uniform. Start by using **A** (aperture priority shooting) mode to take the picture. Set the aperture to the medium setting (about F8 or F11) and allow the camera to automatically select the shutter speed. When shooting a night scene, because the camera sets the exposure to match the dark areas which occupy a majority of the composition and the image often turns out whitish (overexposed), adjust the exposure compensation to  $-1$  or  $-1.5$ . Use **[REC VIEW]** to check the image and adjust the aperture and exposure compensation as necessary.

Image noise can easily occur when shooting at slow shutter speeds. In this case, set **[NOISE REDUCT.]** to **[ON]** to reduce noise.

## 2

### Using manual focus

In cases where you cannot use AF (auto focus) to focus on the subject because the subject is too dark or you cannot focus in time to take pictures, such as during a fireworks display, set the AF mode to **[MF]** (manual focus) and focus manually. To take pictures of night scenes, turn the focus ring of the lens and check whether you can see the lights of the night scene clearly. To take pictures of a fireworks display, adjust the focus of the lens to infinite unless you are using a long focus lens. If you know the approximate distance to the subject, it is recommended that you focus on something that is at the same distance in advance.

☞ “Program shooting” (P. 45), “Aperture priority shooting” (P. 46), “Remote control shooting” (P. 60), “AF mode selection” (P. 54), “Noise reduction” (P. 69), “REC VIEW” (P. 95)



## Activating live view



It is possible to use the LCD monitor as a viewfinder. You can view the exposure or white balance effect and the subject's composition while you take the picture.

### 1 Press the button.

- The mirror is raised and the subject is displayed on the LCD monitor.
- When [AF MODE] was set to [C-AF], it will be set automatically to [S-AF] (or [S-AF+MF] in case it was set to [C-AF+MF]).

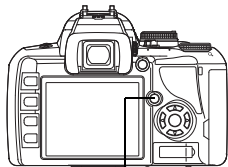





Live View button



## Functions available during live view

The following functions can be used during live view.



### Focusing during live view

- Taking a picture after selecting the AF system  P. 39
- Taking a picture using focus lock  P. 40
- Taking a picture while adjusting the focus manually  P. 42
- Taking a picture while focusing on a face  P. 41
- Taking a picture while checking the focus by enlarging the zone to be focused  P. 43

### Taking a picture while checking the effect

- Taking a picture after comparing the effect of exposure compensation or white balance  P. 43
- Taking a panoramic picture  P. 44

### Switching the indications on the LCD monitor

- Turning off the information display / Displaying the histogram or ruled lines  P. 42
- Checking the subject on the monitor even in low light situations  P. 91

### Notes

- If there is a high-intensity light source within the screen, the image may be displayed darker but will be recorded normally.
- If the live view function is used over a long period, the temperature of the image pickup device rises causing images with high ISO sensitivity to appear noisy and unevenly colored. Either lower the ISO sensitivity or turn off the camera for some time.
- Exchanging the lens will cause live view to stop.
- The following functions are not available during live view.  
C-AF / AE lock / [AEL / AFL]

## The live view mechanism

During live view, the image on the LCD monitor is the same image received by the image pickup device (Live MOS sensor / imager) that is used for shooting. This way you can check on the LCD monitor the effects of exposure compensation or white balance. Moreover, you can also enlarge part of the subject to focus on it or display ruled lines to check that the composition is level.

While the image appears on the LCD monitor during live view, the mirror is raised and the shutter is open. Therefore, you will not be able to check the subject in the viewfinder. Correct metering may not be possible if strong light is coming in through the viewfinder. In such case attach the eyepiece cover.  "Eyepiece cover" (P. 59)

Taking pictures using the viewfinder

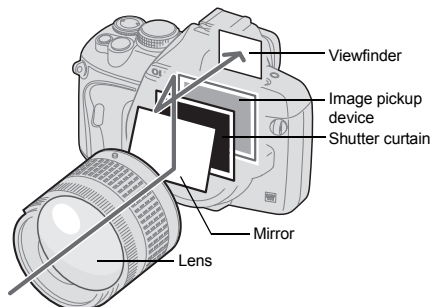

- The light coming in through the lens is reflected on the mirror and you can check the subject in the viewfinder.

Taking pictures using live view

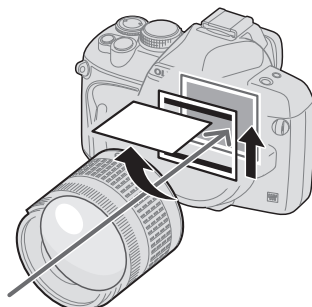

- The mirror is raised and the shutter is open. The image received by image pickup device is displayed on the LCD monitor.

## Taking a picture using live view

In live view you can choose one of 3 available AF systems. The [LIVE VIEW AF MODE] setting will determine when and how focusing is performed.

**Menu**

**MENU** > [1] > [AF] > [LIVE VIEW AF MODE]

### Characteristics of the live view AF mode

LIVE VIEW AF MODE	Using the shutter button		Focus lock	Restrictions on use	AF AREA
	Halfway down	All the way down			
IMAGER AF (factory default setting)	AF operation using the imager	Shooting	Press the shutter button halfway or press the <b>AEL / AFL</b> button.	* Only possible with compatible lenses.	11 AF targets
AF SENSOR	—	AF operation using the AF sensor and then shooting	While holding down the <b>AEL / AFL</b> button, press the shutter button all the way.	None	3 AF targets
HYBRID AF	AF operation using the imager (approximate focus)	AF operation using the AF sensor and then shooting	While holding down the <b>AEL / AFL</b> button, press the shutter button all the way.	None	3 AF targets

\* For the latest information about Olympus lenses compatible with Imager AF, visit the Olympus website. When you are using a lens that is not compatible with [IMAGER AF], [HYBRID AF] will be selected automatically.

### Taking a picture with [IMAGER AF]

- 1 Press the shutter button halfway.
  - When the focus is locked, the AF confirmation mark and AF target mark light up.
- 2 Press the shutter button all the way to take a picture.

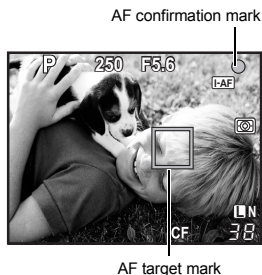

3

Using live view

## Taking a picture with [AF SENSOR]

- 1 **Press the shutter button all the way.**
  - The mirror is lowered and the picture is taken after the focus is locked.
  - The image that was displayed on the monitor before lowering the mirror freezes during focusing.
  - If correct focus cannot be obtained, you will hear the sound of the shutter but the picture will not be taken.
  - To focus in advance, hold down the **AEL / AFL** button and press the shutter button. When the focus is locked, the AF confirmation mark lights up. When the AF confirmation mark is blinking, the focus is not locked.

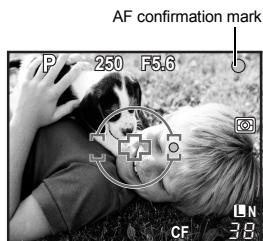

## Taking a picture with [HYBRID AF]

- 1 **Press the shutter button halfway.**
  - The Imager AF will be activated and you can check the subject on the LCD monitor.
  - When the Imager AF achieves approximate focus, the  $\odot$  mark lights up.
- 2 **Press the shutter button all the way.**
  - The picture is taken in a similar way as when using [AF SENSOR].

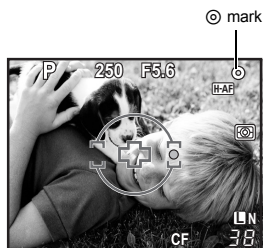

## AF operation during live view

### [IMAGER AF]

When you press the shutter button halfway, AF is performed by the image pickup device. 11 available AF targets allow you to focus on a subject even if it does not appear in the center of the picture.

### [AF SENSOR]

When you press the shutter button all the way, the AF is activated and the picture is taken in the same way as when taking pictures using the viewfinder (AF is not activated on pressing the shutter button halfway).

### [HYBRID AF]

When you press the shutter button halfway, focusing is performed approximately by the Imager AF and you can check the subject on the LCD monitor. When you press the shutter button all the way, the AF is activated in the same way as with the [AF SENSOR] setting. The approximate focusing distance is obtained when the shutter button is pressed halfway so the time it takes to actually take the picture after pressing the shutter button all the way is shortened. When using S-AF+MF, this is very convenient as you can hold the shutter button pressed halfway and finely adjust the focus while checking the LCD monitor.



## Camera status during AF

**Imager AF**  
Halfway down

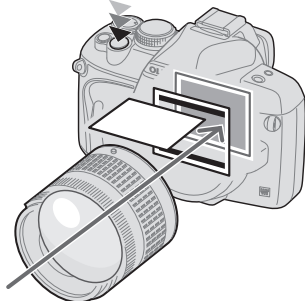

- AF is performed by the image pickup device.

**AF Sensor**  
All the way down

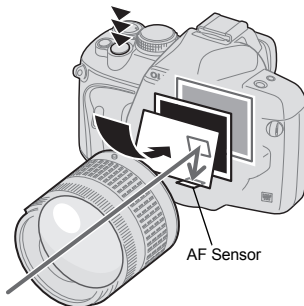

- The mirror is lowered and AF is performed by the AF sensor. (The mirror is down so the image display on the monitor freezes just before pressing the shutter button all the way.)

3

Using Live view

## Using the face detection function

By setting **[FACE DETECT]** to **[ON]**, the camera will detect people's faces in the frame and adjust the focus and metering automatically.

### Direct button

(The setting changes each time the button is pressed.)

### Super control panel

**[FACE DETECT]**

### Menu

**MENU** **[1]** **[18]** **[FACE DETECT]** **[ON]**

- In order to use , **[Fn FACE DETECT]** needs to be set up in the menu in advance. **[FUNCTION]** (P. 90)
- After setting **[FACE DETECT]** to **[ON]** while using , the following functions are automatically set to the best settings for taking pictures of people.

Function	Setting	Ref. page
METERING		P. 50
GRADATION	AUTO	P. 68
LIVE VIEW AF MODE	IMAGER AF	P. 39
AF MODE	S-AF ()	P. 54

# 1 If the camera detects a face, a frame will be displayed in that location.

- When you press the shutter button, the camera will focus on the position of the face detection frame (however, if a single AF target is selected with **[AF AREA]**, the camera will focus on the AF target selected).
- With **[AF SENSOR]** or **[HYBRID AF]**, the camera will focus on the AF target that is closest to the face detection frame.

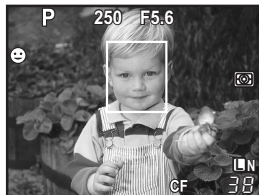

## ! Notes

- During sequential shooting, face detection will work only at the first shot.
- Depending on the subject, the camera may not be able to correctly detect the face.

## Taking a picture using manual focus

During live view, you can take a picture focusing manually while checking the focus on the LCD monitor.

### 1 Set the AF mode to **[S-AF+MF]** or **[MF]**. “AF mode selection” (P. 54)

### 2 Adjust the focus by rotating the focus ring.

- In **[S-AF+MF]** mode, after pressing the shutter button halfway or pressing the **AEL / AFL** button, you can rotate the focus ring to finely adjust the focus before taking the picture.
- Using the enlarged display can be very convenient when adjusting the focus manually.  
 “Enlarged display operation” (P. 43)

## Switching the information display

You can switch the information displayed on the monitor by pressing **INFO** button repeatedly.

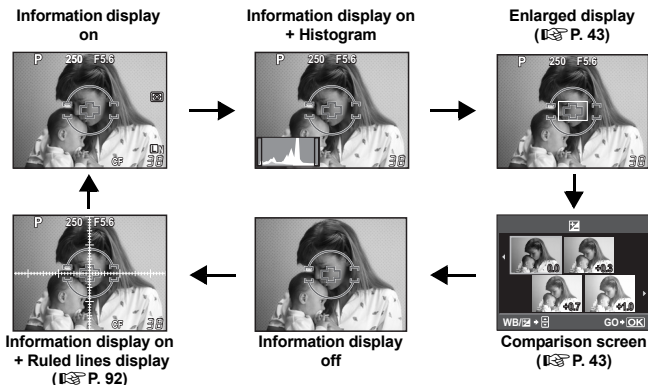

## Taking a picture while comparing the effect

You can check the effect of exposure compensation or white balance on a 4-split screen.

- 1 Press the INFO button repeatedly to display the comparison screen.**
  - “Switching the information display” (P. 42)
  - The exposure compensation comparison screen is displayed. Press  $\odot$  to switch to the white balance comparison screen. Press  $\odot$  to switch the screen.
- 2 Use  $\odot$  or the control dial to select the setting value, then press the  $\odot$  button.**
  - You can take the picture using the set value.



- ! Notes**
- Exposure compensation is not available in **M** mode.
  - This function cannot be used in **SCENE** mode.

## Enlarged display operation

It is possible to enlarge the subject for display. Enlarging the image during MF makes focus confirmation and adjustment easier.

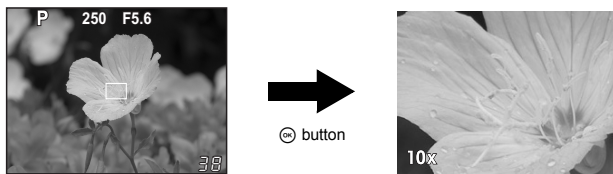

- 1 Press the INFO button repeatedly to display the enlarged display.**
  - “Switching the information display” (P. 42)
  - The enlargement frame will be displayed.
- 2 Use  $\odot$  to move the frame and press the  $\odot$  button.**
  - The area inside the frame is enlarged and displayed.
  - Press and hold the  $\odot$  button to return the enlargement frame to the center after it was moved.
- 3 Turn the control dial to change the magnification (7x / 10x).**
  - Taking the picture or pressing the  $\odot$  button will cancel the enlarged display.
  - During enlarged display, AF will not be activated even in the shutter button is pressed all the way. You can take the picture after checking the focus in the enlarged display.

## Panorama shooting

You can enjoy panorama shooting easily using the OLYMPUS xD-Picture Card. Using OLYMPUS Master (provided CD-ROM) to join a few images shot where the subject's edges overlap, you can create a single panorama composite image.

Panorama shooting is possible up to a maximum of 10 images.

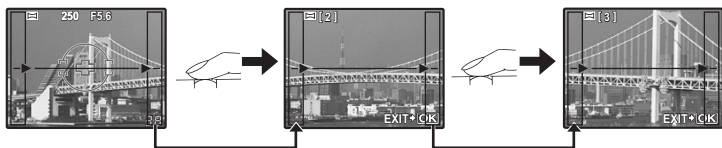

- Try your best to include the common parts of the overlapping images when shooting the subject.

3

Using Live view

### 1 Set the mode. "Types of scene modes" (P. 5)

- Live view is activated.

### 2 Use to specify the direction for joining, then shoot the subject with the edges overlapping.

 : Joins the next image to the right.

 : Joins the next image to the left.

 : Joins the next image to the top.

 : Joins the next image to the bottom.

- Shoot while changing the composition such that the subject overlaps.

- The focus, exposure, etc. will be determined at the first shot.

- The  (warning) mark will be displayed after you have finished taking 10 shots.

- Pressing the  button before shooting the first frame returns to the scene mode selection menu.

- Pressing the  button in the midst of shooting ends the sequence of panorama shooting, and allows you to continue with the next one.

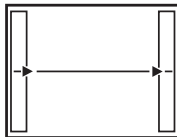

### Notes

- Panorama shooting cannot be done if the OLYMPUS xD-Picture Card is not loaded in the camera.

- During panorama shooting, the image previously taken for position alignment will not be retained. With the frames or other markers for display in the images as a guide, set the composition such that the edges of the overlapping images overlap within the frames.

## Program shooting

P

The camera sets the optimum aperture value and shutter speed automatically according to the subject brightness.

### Set the mode dial to P.

- When the shutter button is half-pressed, the shutter speed and aperture value are displayed on the viewfinder. Releasing the shutter button displays the shutter speed and aperture value on the super control panel screen.

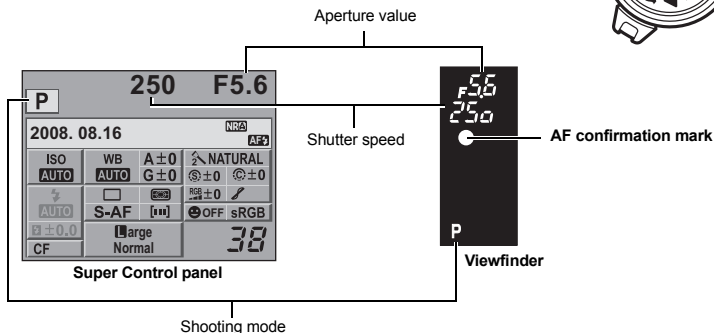

4

Exposure

### Program shift (Ps)

By turning the control dial in the **P** mode, you can change the combination of aperture and shutter speed while maintaining the optimum exposure.

- “Program line diagram (**P** mode)” (P. 122)
- The program shift setting will not be canceled after shooting. To cancel program shift setting, turn the control dial until the shooting mode indication **Ps** on the viewfinder or super control panel changes to **P** or turn off the power.
- Program shift is not available when you are using a flash.

#### TIPS

#### The shutter speed and aperture value are blinking:

- The optimum exposure cannot be obtained.  
For details, see “Exposure warning display” (P. 123).



Program shift

The camera sets the optimum shutter speed automatically for the aperture value you have selected. When you open the aperture (decrease the aperture value), the camera will focus within a shorter range (shallow depth of field) and produce a picture with a blurred background. When you close the aperture (increase the aperture value), the camera will focus within a longer range. Use this mode when you wish to add changes to the background representation. Before shooting, you can use the preview function to check how the background will look in your picture.  "Preview function" (P. 49)

When the aperture value (f-number) is decreased.



When the aperture value (f-number) is increased.



Set the mode dial to **A** and turn the control dial to set the aperture value.

**4**

Exposure

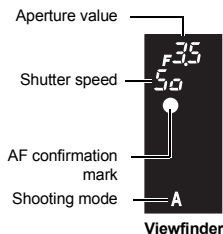

Open the aperture (f-number is decreased)

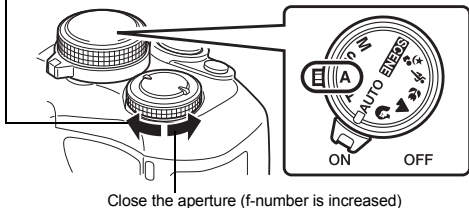

### TIPS

**To check the depth of field with the selected aperture value:**

→ See "Preview function" ( P. 49).

**Shutter speed is blinking:**

→ The optimum exposure cannot be obtained. For details, see "Exposure warning display" ( P. 123).

## Shutter priority shooting

**S**

The camera sets the optimum aperture value automatically for the shutter speed you have selected. Set the shutter speed depending on the type of effect you want. A higher shutter speed allows you to capture a fast-moving subject without blur, and a slower shutter speed blurs a moving subject, creating a feeling of speed or motion.

A fast shutter speed can freeze a fast action scene without any blur.



A slow shutter speed will blur a fast action scene. This blurring will give the impression of dynamic motion.

Set the mode dial to **S** and turn the control dial to set the shutter speed.

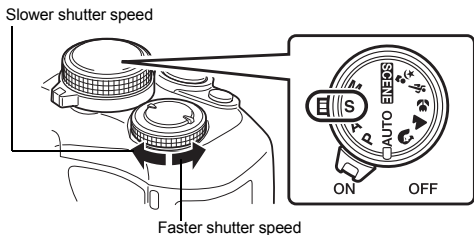
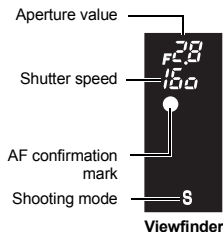

### TIPS

#### The picture looks blurred:

→ The possibility of camera shake spoiling your picture increases greatly during macro or ultra-telephoto shooting. Raise the shutter speed or use a monopod or tripod to stabilize the camera.

#### The aperture value is blinking:

→ The optimum exposure cannot be obtained. For details, see "Exposure warning display" (P. 123).

**4**

Exposure

Allows you to set the aperture and shutter speed manually. You can check how much it differs from the appropriate exposure by using the exposure level indicator. This mode gives you more creative control, allowing you to make whatever settings you like, regardless of the correct exposure.

#### Set the mode dial to **M** and turn the control dial to set the value.

- Shutter speed: Turn the control dial to set the value.
- Aperture value: Turn the control dial while holding down the  button to set the value.
- The range of aperture values available varies with the lens type.
- The shutter speed can be set to 1/4000 – 60 sec. or **[BULB]**.
- The aperture value and shutter speed change in 1/3 EV increments as the dial is turned.

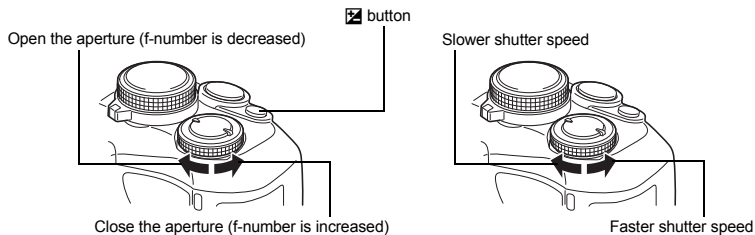

- In **M** mode the exposure level indicator will appear on the super control panel screen. It shows the difference (ranging from -3 EV to +3 EV) between the exposure value calculated by the currently selected aperture and shutter speed and the exposure value considered optimum by the camera. If the difference exceeds  $\pm 3$  EV,  will appear in red on both sides of the indicator.

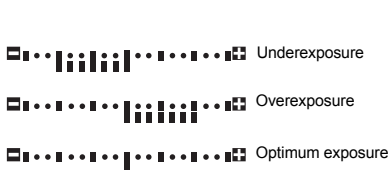

Exposure level indicator

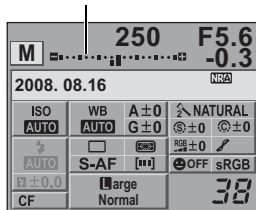

#### Noise in images

During shooting at slow shutter speeds, noise may appear on-screen. These phenomena are caused when current is generated in those sections of the image pickup device that are not normally exposed to light, resulting in a rise in temperature in the image pickup device or image pickup device drive circuit. This can also occur when shooting with a high ISO setting in a high-temperature environment. To reduce this noise, the camera activates the noise reduction function.

 "Noise reduction" (P. 69)



#### TIPS

#### The picture looks blurred:

→ The use of a monopod or tripod is recommended when taking a picture at slow shutter speed.

#### To switch the operation between setting the shutter speed and aperture value:

→ You can set the aperture value using only the control dial. "DIAL FUNCTION" (P. 88)

#### Notes

- Exposure compensation is not available in **M** mode.

## Bulb shooting

You can take a picture with a bulb exposure time in which the shutter stays open as long as you hold down the shutter button.

Bulb shooting can also be done using an optional remote control (RM-1).

"Bulb shooting with the remote control" (P. 61)

#### In **M** mode, set the shutter speed to [BULB].

- [buLb] is displayed in the viewfinder and [BULB] on the super control panel.

#### TIPS

#### To automatically end bulb shooting after a specified period of time:

→ You can set the maximum time for bulb shooting. "BULB TIMER" (P. 92)

#### To fix the focus during manual focus shooting:

→ You can fix the focus so the focus does not change even if the focus ring is turned during exposure.

"BULB FOCUSING" (P. 87)

#### Notes

- The following functions are not available during bulb shooting.  
Sequential shooting / self-timer shooting / AE bracket shooting

## Preview function

The viewfinder shows the focused area (depth of field) with the selected aperture value.

For the preview function to work by pressing the button, it is necessary to set the function of the button on the menu beforehand.

"[] FUNCTION" (P. 90)

#### Press the button to use the preview function.

- When [] FUNCTION is assigned to [LIVE PREVIEW], pressing the button automatically switches the camera to live view for a preview of the picture on the monitor.

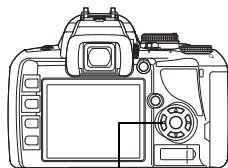

button

## Changing the metering mode



There are 5 ways to measure the subject brightness: Digital ESP metering, Center weighted averaging metering, and 3 types of spot metering. Select the most suitable mode for the shooting conditions.

### Super control panel

: [METERING]

### Menu

MENU : [METERING]

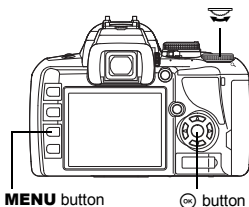

### Setting display



Viewfinder

- : Center weighted averaging metering
- : Spot metering
- : Spot metering – highlight control
- : Spot metering – shadow control

MENU button

button

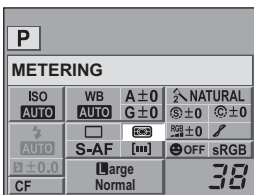

4

Exposure

### Digital ESP metering

The camera measures the light levels and calculates the light level differences in 49 separate areas of the image. This mode is recommended for general use. Setting the AF synchronized function to [ESP+AF] enables metering centered around the AF target that is in focus with AF.

### Center weighted averaging metering

This metering mode provides the average metering between the subject and the background lighting, placing more weight on the subject at the center. Use this mode when you do not want the light level of the background to affect the exposure value.

### Spot metering

The camera meters a very small area around the center of the subject, defined by the spot metering area mark in the viewfinder. Use this mode when there is very strong backlight.

### HI Spot metering – highlight control

When the overall background is bright, white areas of the image will come out gray if you use the camera's automatic exposure. Using this mode enables the camera to shift to over-exposure, allowing accurate white reproduction. Metering area is the same as spot metering.

### SH Spot metering – shadow control

When the overall background is dark, black areas of the image will come out gray if you use the camera's automatic exposure. Using this mode enables the camera to shift to under-exposure, allowing accurate black reproduction. Metering area is the same as spot metering.

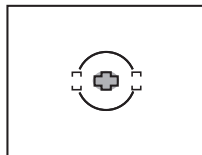

: Metering area

## Exposure compensation



In some situations, you may get better results if you manually compensate (adjust) the exposure value set automatically by the camera. In many cases, bright subjects (such as snow) will turn out darker than their natural colors. Adjusting toward + makes these subjects closer to their real shades. For the same reason, adjust toward – when shooting dark subjects. The exposure can be adjusted in a range of  $\pm 5.0$  EV.

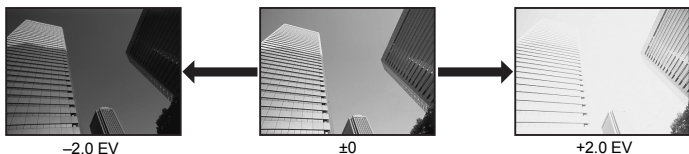

### Direct button



- The EV step interval is 1/3 EV.



Viewfinder

Exposure compensation value

Adjust toward –

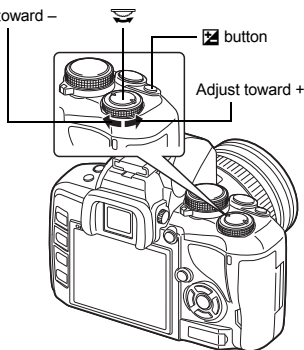

Exposure compensation indicator

- The exposure compensation indicator is displayed. The exposure compensation indicator will not be displayed when the exposure is compensated by 0.



- If the exposure compensation value exceeds the scale of the exposure compensation indicator, a red ◀▶ is displayed on the left and right edges of the indicator.

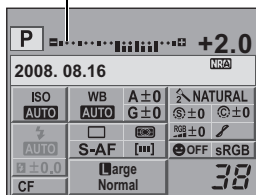

### TIPS

**To adjust the exposure compensation using only the control dial:**

→ You can set the exposure compensation value without pressing button.

"DIAL FUNCTION" (P. 88)

### Notes

- Exposure compensation is not available in **M** and **SCENE** modes.

The metered exposure value can be locked with the **AEL / AFL** button (AE lock). Use AE lock when you want a different exposure setting from the one that would normally apply under the current shooting conditions.

Normally, pressing the shutter button halfway locks both AF (auto focus) and AE (automatic exposure), but you can lock the exposure alone by pressing the **AEL / AFL** button.

**Press the AEL / AFL button at the position where you wish to lock the metering values and the exposure will be locked. The exposure is locked while the AEL / AFL button is pressed. Now press the shutter button.**

- Releasing the **AEL / AFL** button cancels AE lock.

### TIPS

#### To lock the exposure:

→ You can lock the metering result so that it is not canceled when the **AEL / AFL** button is released.  "AEL / AFL MEMO" (P. 89)

#### To activate AE lock with a set metering mode:

→ You can set the metering mode for locking the exposure with the AE lock.  "AEL Metering" (P. 92)

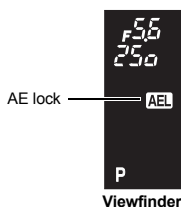
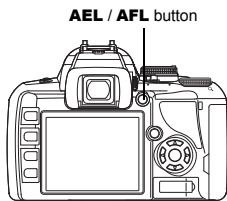

## AE bracketing

The camera automatically shoots a number of pictures at different exposure values for each frame. Even in conditions where correct exposure is difficult to obtain (such as a backlit subject or a scene at dusk), you can pick the picture you prefer from a selected number of frames with a variety of different exposure settings. The pictures are taken in the following order: Picture with optimum exposure, picture adjusted in - direction, and picture adjusted in + direction.

e.g.) When BKT is set to **[3 F 1.0 EV]**



Compensation value: 0.3, 0.7 or 1.0

Number of frames: 3

Menu

MENU ▸ [C] ▸ [AE BKT]

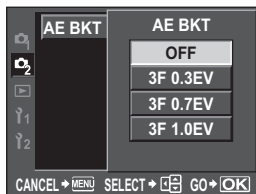

### Start shooting.

- In single-frame shooting, the exposure changes every time the shutter button is pressed.
- In sequential shooting, hold down the shutter button until the selected number of frames are taken.
- Releasing the shutter button stops auto bracketing shooting. When it stops, **BKT** is displayed in green on the super control panel.

### How AE bracketing compensates exposure in each shooting mode

Depending on the selected shooting mode, exposure is compensated in the following way:

- P** mode : Aperture value and shutter speed
- A** mode : Shutter speed
- S** mode : Aperture value
- M** mode : Shutter speed



Viewfinder

The exposure value for the next shot is displayed during shooting.

### TIPS

#### To apply AE bracketing to the exposure value you have compensated:

→ Compensate the exposure value, then use the AE bracketing feature. AE bracketing is applied to the exposure value you have compensated.

## ISO sensitivity setting

ISO

The higher the ISO value, the greater the camera's light sensitivity and the better its ability to shoot in low light conditions. However, higher values may give pictures a grainy appearance.

Super control panel

⏪ ▸ [ISO]

Menu

MENU ▸ [C] ▸ [ISO]

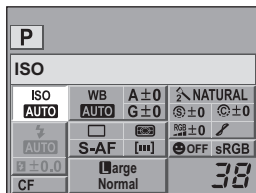

**[AUTO]:** The sensitivity is set automatically according to the shooting conditions. With the **[ISO-AUTO SET]** setting, you can set the maximum ISO that is set automatically.

🔍 "ISO-AUTO SET" (P. 92)

**[100 – 1600]:** Fixed ISO sensitivity.

### TIPS

#### To automatically set the optimal ISO in M mode:

→ Normally, the AUTO setting is not available in **M** mode, but you can set it for use in all shooting modes. 🔍 "ISO-AUTO" (P. 92)

4

Exposure

## 5 Focusing and shooting functions

### AF mode selection

**AF**

The three focus modes S-AF, C-AF, and MF are available with this camera. You can take pictures by combining S-AF or C-AF mode with MF mode.

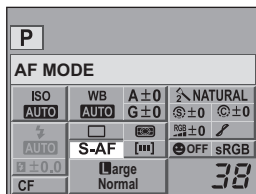
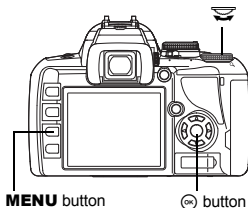
**Super control panel** : [AF MODE]**Menu****MENU**  $\blacktriangleright$  [M2]  $\blacktriangleright$  [AF MODE]**5****Focusing and shooting functions**

### S-AF (single AF)

Focusing is performed once when the shutter button is pressed halfway.

If focusing fails, release your finger from the shutter button and press it halfway again. This mode is suitable for taking pictures of still subjects or subjects with limited movement.

#### Press the shutter button halfway.

- When the focus is locked, the AF confirmation mark lights up.
- A beep sound is output when the subject is in focus.

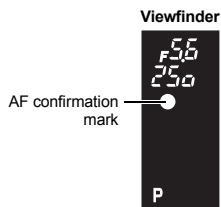

#### TIPS

#### When it is difficult to focus in the AF mode in low-light conditions:

- The built-in flash can function as an AF illuminator. This helps with focusing in low-light conditions in the AF mode.  "AF ILLUMINAT." (P. 87)

## C-AF (continuous AF)

The camera repeats focusing while the shutter button remains pressed halfway. When the subject is in motion, the camera focuses on the subject in anticipation of its movement (Predictive AF). Even if the subject moves or you change the composition of the picture, the camera continues trying to focus.

### Press the shutter button halfway and keep it in this position.

- When the subject is in focus and locked, the AF confirmation mark lights up.
- The AF target does not light up, even when the subject is in focus.
- The camera repeats focusing. Even if the subject moves or even if you change the composition of the picture, focusing is tried continuously.
- A beep sound is output when the subject is in focus. The beep sound is not output after the third continuous AF operation, even when the subject is in focus.

## MF (manual focus)

This function allows you to manually focus on any subject.

### Adjust the focus using the focus ring.

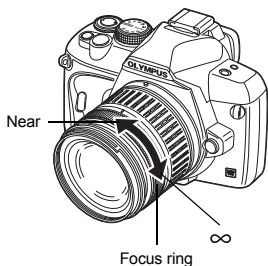

### TIPS

#### To change the rotational direction of the focus ring:

→ You can select the rotational direction of the focus ring to suit your preference for how the lens adjusts to the focusing point.  "FOCUS RING" (P. 87)

#### For information on whether the subject is in focus (Focus aid):

→ When you focus the lens on a subject manually (by turning the focus ring), the AF confirmation mark lights. When  is set with [AF AREA], AF confirmation lights up if the subject is in focus at the center AF target.

## Simultaneous use of S-AF mode and MF mode (S-AF+MF)

This function allows you to fine-adjust the focus manually by turning the focus ring after AF is performed in the S-AF mode. When the shutter button is not pressed, MF operation is available.

- You can fine-adjust the focus with the focus ring if you have pressed the shutter button halfway and AF is confirmed.

### Notes

- If the shutter button is pressed again after fine-adjusting the focus with the focus ring, the AF is activated and your adjustments are canceled.

## Simultaneous use of C-AF mode and MF mode (C-AF+MF)

Focus with the focus ring and press the shutter button halfway to activate C-AF mode.

- While the shutter button is kept pressed, MF cannot be used.
- When the shutter button is not pressed, focusing with MF is possible.

### TIPS

#### Another way to adjust focus manually in C-AF mode:

→ You can set the **AEL / AFL** button to operate C-AF. "AEL / AFL" (P. 89)

### Notes

- If the shutter button is pressed again after fine-adjusting the focus with the focus ring, the AF is activated and your adjustments are canceled.

## AF target selection

This camera has 3 AF targets for focusing on the subject with auto focus. You can select only one of the AF targets.

When **[LIVE VIEW AF MODE]** is set to **[IMAGER AF]**, 11 AF targets will be available during live view. "Taking a picture using live view" (P. 39)

### [AUTO] or [•••]

Focuses using the 3 AF targets.



Focuses using the left AF target.



Focuses using the center AF target.



Focuses using the right AF target.

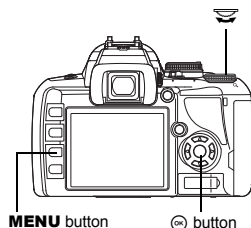
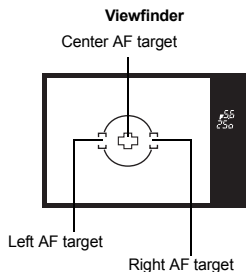

### Super control panel

: **[AF AREA]**

### Menu

**MENU** > > **[AF AREA]**

- With the **[IMAGER AF]** setting, target selection is only possible using the super control panel. Turn the control dial to select the AF target.

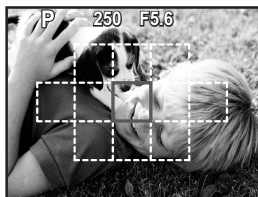

When selecting the AF target with the **[IMAGER AF]** setting

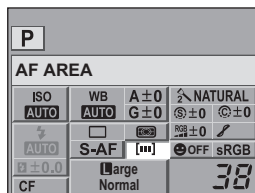



## Focus lock – If correct focus cannot be obtained

The camera's auto focus may not be able to focus on the subject in situations such as when the subject is not in the center of the frame. If this happens, the easiest solution is to use focus lock. Use this when composing the subject outside of the AF targets or when the subject is difficult to focus on.

### 1 Adjust the AF target with the subject to be focused and press the shutter button halfway until the AF confirmation mark lights up.

- The focus is locked. The AF confirmation mark and the AF target in focus light up in the viewfinder.
- If the AF confirmation mark blinks, press the shutter button halfway again.
- While the shutter button is being pressed, the super control panel disappears.

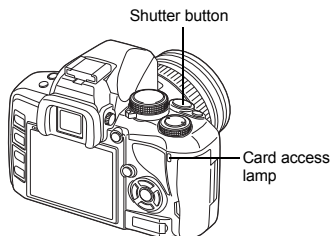

e.g.) The camera focuses using the center AF target.

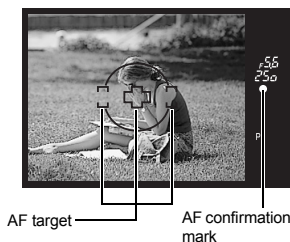

### 2 While pressing the shutter button halfway, move to the desired composition and press the button all the way.

- The card access lamp blinks while the picture is being stored on the card.



### If the subject has lower contrast than its surroundings

If the contrast of the subject is weak, such as when the lighting is insufficient or the subject cannot be seen clearly because of fog, the focus may not be achieved. Focus (focus lock) on a high-contrast object the same distance away as the intended subject, recompose your shot and then take the picture.

## Sequential shooting



Single-frame shooting Shoots 1 frame at a time when the shutter button is pressed (normal shooting mode).

Sequential shooting Shoots at 3.5 frames / sec. for as long as the shutter button is pressed (during JPEG).

- Press the shutter button fully and keep it pressed. The camera will take pictures in sequence until you release the button.
- Focus, exposure, and white balance are locked at the first frame (during S-AF, MF).

### Notes

- During sequential shooting, if the battery check blinks due to low battery, the camera stops shooting and starts saving the pictures you have taken on the card. The camera may not save all of the pictures depending on how much battery power remains.

### Setting method

#### Direct button



#### Super control panel

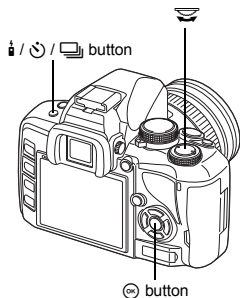

### Setting display

Single-frame shooting /  
Sequential shooting



1-d:  
Single-frame shooting  
b-d:  
Sequential shooting

Self-timer



12 SELF:  
12-second self-timer  
2 SELF:  
2-second self-timer

Remote control



0 r-c-d:  
0 second  
2 r-c-d:  
2 seconds

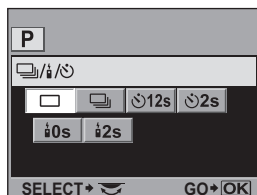

- Anti-shock display ( P. 61):

The symbol displayed next to the icon on the super control panel indicates that anti-shock is activated.

## Self-timer shooting



This function lets you take pictures using the self-timer. You can set the camera to release the shutter after either 12 or 2 seconds. Fix the camera securely on a tripod for self-timer shooting. For the setting method, see "Sequential shooting" (P. 58).

### Press the shutter button all the way.

- When **12s** is selected:  
First, the self-timer lamp lights up for approximately 10 seconds, then it blinks for approximately 2 seconds and the picture is taken.
- When **2s** is selected:  
The self-timer lamp blinks for approximately 2 seconds, and then the picture is taken.
- To cancel the activated self-timer, press the / / button.

Self-timer lamp

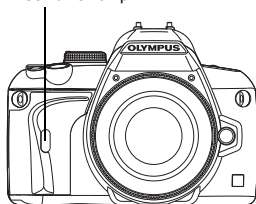

### ! Notes

- Do not press the shutter button while standing in front of the camera; this could result in the subject being out of focus since focusing is performed when the shutter button is pressed halfway.

### Eyepiece cover

When shooting without looking through the viewfinder, attach the eyepiece cover to the viewfinder to prevent the light entering the viewfinder from changing the exposure. Attach the eyepiece cover after removing the eyecup as illustrated. The same applies when replacing with an optional eyecup.

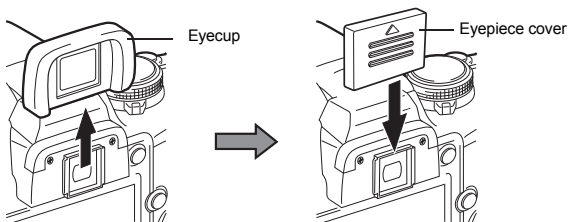

## Remote control shooting



By using the optional remote control (RM-1), you can take a picture with yourself in it or a night scene without touching the camera.

The camera can be set to release the shutter either right away or 2 seconds after the shutter button on the remote control is pressed. Bulb shooting is also possible when using the optional remote control.

For the setting method, see “Sequential shooting” (P. 58).

**Mount the camera securely on a tripod, point the remote control at the remote control receiver on the camera and press the shutter button on the remote control.**

- When **10s** is selected:  
The focus and exposure are locked, the remote control lamp blinks and the picture is taken.
- When **12s** is selected:  
The focus and exposure are locked, the remote control lamp blinks, and after approximately 2 seconds the picture is taken.

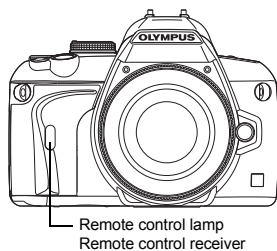

### Transmitted signal effective area

Point the remote control at the remote control receiver of the camera within the effective area as shown below.

When powerful lighting such as direct sunlight is shining on the remote control receiver, or when fluorescent light or devices emitting electrical or radio waves are nearby, it could narrow the effective area.

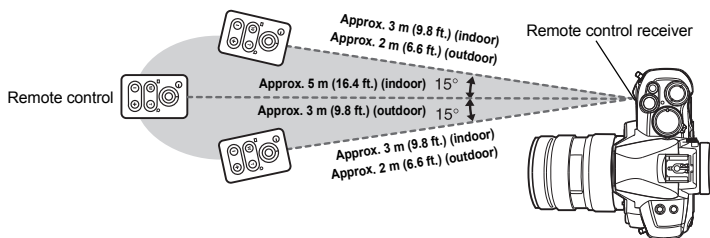

### TIPS

**The remote control lamp does not blink after the shutter button on the remote control is pressed:**

- The transmitted signal may not be effective if the remote control receiver is exposed to powerful lighting. Move the remote control closer to the camera and press the shutter button on the remote control again.
- The transmitted signal may not be effective if the remote control is too far from the camera. Move the remote control closer to the camera and press the shutter button on the remote control again.
- There is signal interference. Change the channel as described in the remote control's manual.

**To cancel the remote control shooting mode:**

- The remote control shooting mode will not be canceled after shooting. Press the / / button to set to [□] (single-frame shooting), etc.

**To use the shutter button on the camera in the remote control shooting mode:**

- The shutter button on the camera still works even in the remote control shooting mode.

## ! Notes

- The shutter will not be released if the subject is not in focus.
- Under bright light conditions, the remote control lamp may be difficult to see, making it hard to determine whether or not the picture has been taken.
- Zoom is not available on the remote control.

## Bulb shooting with the remote control

Set the mode dial to **M**, then set the shutter speed to **[BULB]**. (☞ “Bulb shooting” (P. 49))

Press the **W** button on the remote control to open the shutter. When the time set in “BULB TIMER” (☞ P. 92) elapses, the shutter closes automatically.

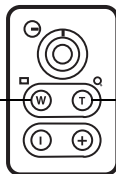

Press the **T** button to close the shutter.

## Anti-shock

You can select the interval from the time the mirror is raised until the shutter is released. This diminishes camera shake caused by vibrations when the mirror moves. This feature can be useful in astrophotography and microscope photography or other photographic situations where a very slow shutter speed is used, and camera vibration needs to be kept to a minimum.

- 1** **MENU** > [2] > **[ANTI-SHOCK[♦]]**
- 2** Select the time delay after the mirror is raised and until the shutter is released from 1 to 30 seconds and press the **OK** button.
- 3** Anti-shock is added to the shooting functions individually (single-frame shooting, sequential shooting, self-timer shooting, and remote control shooting). For the setting method, see “Sequential shooting” (☞ P. 58).

## 6 Record mode, white balance, and picture mode

### Selecting the record mode

You can select a record mode in which to take pictures. Choose the record mode that is best for your purpose (printing, editing on a PC, website editing, etc.).

#### Recording formats

##### JPEG

For JPEG images, select a combination of image size (**L**, **M**, **S**) and compression rate (SF, F, N, B). An image consists of pixels (dots). When you enlarge an image with a low pixel count, it will be displayed as a mosaic. If an image has a high pixel count, the file size (amount of data) will be larger and the number of storable still pictures will be lower. The higher the compression, the smaller the file size. However, the image will have less clarity when played back.

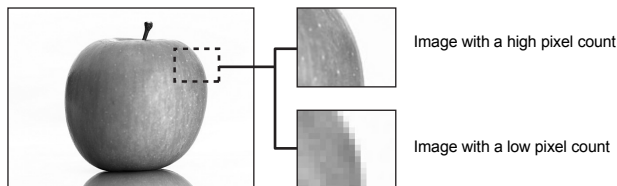

Image becomes clearer

Application	Number of pixels	Pixel count	Compression rate			
			SF (Super Fine) 1/2.7	F (Fine) 1/4	N (Normal) 1/8	B (Basic) 1/12
Select for the print size	<b>L</b> (Large)	3648 x 2736	<b>L</b> SF	<b>L</b> F	<b>L</b> N	<b>L</b> B
		3200 x 2400	<b>M</b> SF	<b>M</b> F	<b>M</b> N	<b>M</b> B
	2560 x 1920					
	1600 x 1200					
For small-sized prints and use on a web site	<b>S</b> (Small)	1280 x 960	<b>S</b> SF	<b>S</b> F	<b>S</b> N	<b>S</b> B
		1024 x 768				
		640 x 480				

Number of pixels increases

## RAW

This is unprocessed data that has not undergone changes in white balance, sharpness, contrast or color. To display as an image on the computer, use OLYMPUS Master. RAW data cannot be displayed on a different camera or by using common software, and it cannot be selected for print reservation.

It is possible to edit images taken with the record mode set to RAW data using this camera.

☞ "Editing still images" (P. 82)

## Selecting the record mode

### JPEG

For JPEG, you can register 4 combinations of images sizes (**L**, **M**, **S**) and compression rates (SF, F, N, B) from the 12 total combinations available. ☞ "SET" (P. 93)

When you select the **M** or **S** image size, you can further select the pixel size.

☞ "PIXEL COUNT" (P. 93)

### RAW+JPEG

Records both a JPEG and RAW image at the same time each time you take a picture.

### RAW

Records the image in RAW data format.

e.g.) The following 9 record modes are available when **L**F / **L**N / **M**N / **S**N are registered.

RAW : RAW

JPEG : **L**F / **L**N / **M**N / **S**N

RAW+JPEG : RAW+**L**F / RAW+**L**N / RAW+**M**N / RAW+**S**N

### Super control panel

☞ ▶ [ ] : [◀:-]

### Menu

**MENU** ▶ [ ] ▶ [◀:-]

### TIPS

To find out the file size / number of storable still pictures for each record mode:

→ "Record mode and file size / number of storable still pictures" (☞ P. 125)

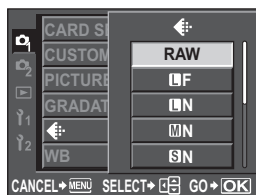
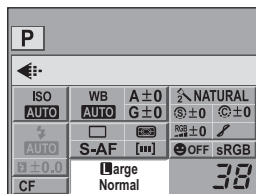

6

Record mode, white balance, and picture mode

## Selecting the white balance

Color reproduction differs depending on the light conditions. For instance, when daylight or tungsten lighting is reflected on white paper, the shade of white produced will be slightly different for each. With a digital camera, white color can be adjusted to reproduce more natural white with a digital processor. This is called white balance. There are 4 options for setting the WB with this camera.

### Auto white balance [AUTO]

This function enables the camera to automatically detect white in images and adjust the color balance accordingly. Use this mode for general use.

### Preset white balance

8 different color temperatures are programmed on this camera covering a variety of indoor and outdoor lighting including fluorescent lights, light bulbs, and flashes. For example, use preset WB when you want to reproduce more red in the picture of a sunset, or capture a warmer artistic effect under artificial lighting.

### Custom white balance [CWB]

You can set the color temperature from 2000 K to 14000 K. For details on color temperature, refer to "White balance color temperature" (P. 125).

 "Setting the auto / preset / custom white balance" (P. 65)











### One-touch white balance

You can set the optimum white balance for the shooting conditions by pointing the camera at a white object like a sheet of white paper. The white balance achieved with this setting is saved as one of the preset WB settings.

 "Setting the one-touch white balance" (P. 66)

6

Record mode, white balance, and picture mode

WB mode	Light conditions
AUTO	Used for most light conditions (when there is a white portion framed in the viewfinder). Use this mode for general use.
 5300 K	For shooting outdoors on a clear day, or to capture the reds in a sunset or the colors in a fireworks display.
 7500 K	For shooting outdoors in the shadows on a clear day.
 6000 K	For shooting outdoors on a cloudy day.
 3000 K	For shooting under a tungsten light.
 4000 K	For shooting under white fluorescent lighting.
 4500 K	For shooting under a neutral white fluorescent lamp.
 6600 K	For shooting under a daylight fluorescent lamp.
 5500 K	For flash shooting.
	Color temperature set by one-touch WB.  "Setting the one-touch white balance" (P. 66)
CWB	Color temperature set in custom white balance menu. This can be set from 2000 K to 14000 K. When the value has not been set, it is set to 5400 K.



You can adjust the white balance by selecting the appropriate color temperature for the light conditions.

**Super control panel** : [WB]

- Custom white balance is set by selecting [CWB] and turning the control dial while pressing down the button.

**Menu** **MENU** : [WB]

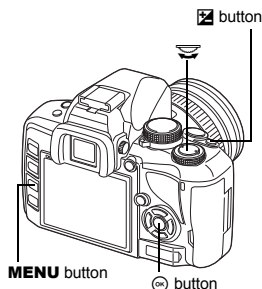

## Setting display

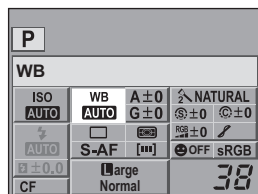
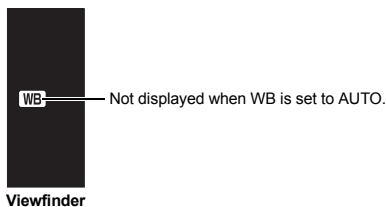

### TIPS

#### When subjects that are not white appear white:

→ In the auto WB setting, if there is no near-white color in the image framed in the screen, the white balance will not be correctly determined. In such a case, try preset WB or one-touch WB settings.

## WB compensation

This function lets you make fine changes to the auto WB and preset WB settings.

**Super control panel** : [WB $\pm$ ]

**Menu** **MENU** : [WB]

- Select the white balance to adjust and press .

#### Adjusting the white balance in the A direction (Amber-Blue)

Depending on the original WB conditions, the image will become more amber when adjusted toward +, and bluer when adjusted toward –.

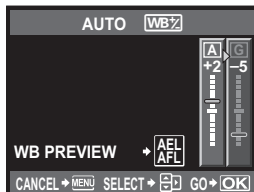

## Adjusting the white balance in the G direction (Green-Magenta)

Depending on the original WB conditions, the image will become greener when adjusted toward +, and magenta when adjusted toward –.

- The white balance can be adjusted in 7 increments in each direction.

### TIPS

#### Checking the white balance you have adjusted:

→ After setting the compensation value, point the camera at the subject to take test shots. When the **AEL / AFL** button is pressed, sample images that have been taken with the current WB settings are displayed.

#### Adjusting all WB mode settings at once:

→ See "ALL [WB?]" (P. 93).

## Setting the one-touch white balance



This function is useful when you need a more precise white balance than preset WB can provide. Point the camera at a sheet of white paper under the light source you want to use to determine the white balance. The optimum white balance for the current shooting conditions can be saved in the camera. This is useful when shooting a subject under natural light, as well as under various light sources with different color temperatures.

Set [FUNCTION] to [ ] beforehand. (P. 90)

### 1 Point the camera at a sheet of white paper.

- Position the paper so that it fills the viewfinder. Make sure there are no shadows.

### 2 While holding down the button, press the shutter button.

- The one-touch white balance screen appears.

### 3 Select [YES] and press the button.

- The white balance is registered.
- The registered white balance will be stored in the camera as a preset WB setting. Turning the power off does not erase the data.

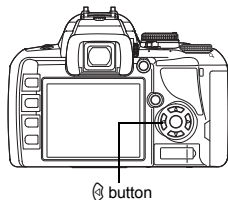

### TIPS

#### After pressing the shutter button, [WB NG RETRY] is displayed:

→ When there is not enough white in the image, or when the image is too bright, too dark or the colors look unnatural, you cannot register the white balance. Change the aperture and shutter speed settings, then repeat the procedure from Step 1.

## Picture mode

You can select image tone to create unique image effects. You can also fine-adjust image parameters such as contrast and sharpness for each mode. The adjusted parameters are recorded in each picture effect mode.

- [**V**] **VIVID** : Produces vivid colors.
- [**N**] **NATURAL** : Produces natural colors.
- [**M**] **MUTED** : Produces flat tones.
- [**P**] **PORTRAIT** : Produces beautiful skin tones.
- [**MONOTONE**] : Produces black and white tone.

### Super control panel

 : [PICTURE MODE]

### Menu

**MENU** > [**P**] >  
[PICTURE MODE]

The adjustable parameters are classified according to the picture modes.

The individual parameters are as follows.

- [**C**] **CONTRAST** : Distinction between light and dark.
- [**S**] **SHARPNESS** : Sharpness of the image.
- [**SAT**] **SATURATION** : Vividness of the color.
- [**B&W**] **B&W FILTER** : Creates a black and white image. The filter color is brightened and the complementary color is darkened.

[**N**] **NEUTRAL** : Creates a normal black and white image.

[**Ye**] **YELLOW** : Reproduces clearly defined white cloud with natural blue sky.

[**Or**] **ORANGE** : Slightly emphasizes colors in blue skies and sunsets.

[**R**] **RED** : Strongly emphasizes colors in blue skies and brightness of crimson foliage.

[**G**] **GREEN** : Strongly emphasizes colors in red lips and green leaves.

[**PICT. TONE**] : Colors the black and white image.

[**N**] **NEUTRAL** : Creates a normal black and white image.

[**S**] **SEPIA** : Sepia

[**B**] **BLUE** : Bluish

[**P**] **PURPLE** : Purplish

[**G**] **GREEN** : Greenish

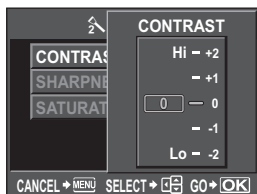
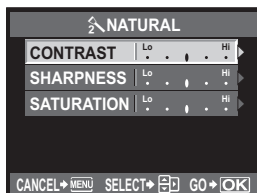
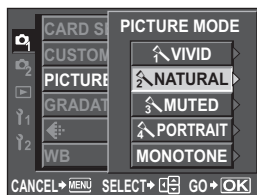

6

Record mode, white balance, and picture mode

## Gradation

In addition to the **[NORMAL]** gradation setting, you can select from 3 other gradation settings.

**[HIGH KEY]** : Gradation for a bright subject.

**[LOW KEY]** : Gradation for a dark subject.

**[AUTO]** : Divides the image into detailed regions and adjusts the brightness separately for each region. This is effective for images with areas of large contrast in which the whites appear too bright or the blacks appear too dark.

**[NORMAL]** : Use **[NORMAL]** mode for general uses.



**HIGH KEY**

Suitable for a subject that is mostly highlighted.

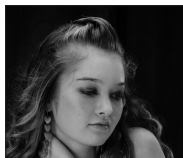

**LOW KEY**

Suitable for a subject that is mostly shadowed.

**Super control panel**

 : **[GRADATION]**

**Menu**

**MENU**  **[G]**  **[GRADATION]**

6

### Notes

- Contrast adjustment does not work when set to **[HIGH KEY]**, **[LOW KEY]**, or **[AUTO]**.

## Noise reduction

This function reduces the noise that is generated during long exposures. When shooting night scenes, shutter speeds are slower and noise tends to appear in images. With **[NOISE REDUCT.]**, you can let the camera reduce noise automatically to produce clearer images. When set to **[AUTO]**, noise reduction will be activated only when the shutter speed is slow. When set to **[ON]**, noise reduction will always be activated. While noise reduction is activated, it takes about twice the usual time to take a picture.



OFF



ON / AUTO

### Menu

**MENU** ▶ **[Q]** ▶ **[NOISE REDUCT.]**

- The noise-reduction process is activated after shooting.
- The card access lamp blinks during the noise-reduction process. You cannot take more pictures until the card access lamp turns off.
- **[busy]** is displayed on the viewfinder while noise reduction is operating.

### ! Notes

- When the **[SCENE]** mode is set to **[S&L]**, **[NOISE REDUCT.]** is fixed to **[ON]**.
- During sequential shooting, **[NOISE REDUCT.]** is **[OFF]** automatically.
- This function may not work effectively with some shooting conditions or subjects.

## Noise filter

You can select the noise processing level. Use **[STANDARD]** for general use. **[HIGH]** is recommended during high sensitivity shooting.

### Menu

**MENU** ▶ **[Q]** ▶ **[NOISE FILTER]**

## Flash mode setting



The camera sets the flash mode according to various factors such as firing pattern and flash timing. Available flash modes depend on the exposure mode. The flash modes are available to optional external flashes.

## Auto flash AUTO

The flash fires automatically in low light or backlight conditions. To shoot a subject with backlighting, position the AF target over the subject.

Red-eye reduction flash  /  

In the red-eye reduction flash mode, a series of pre-flashes are emitted just before the regular flash fires. This helps accustom the subject's eyes to the bright light and minimizes the red-eye phenomenon. In **S / M** mode, the flash always fires.



The subject's eyes appear red

 Notes

- After the pre-flashes, it takes about 1 second before the shutter is released. Hold the camera firmly to avoid camera shake.
- Effectiveness may be limited if the subject is not looking directly at pre-flashes, or if the shooting range is too far. Individual physical characteristics may also limit effectiveness.

Slow synchronization (1st curtain)  SLOW

The slow synchronization flash is designed for slow shutter speeds. Normally, when shooting with a flash, shutter speeds cannot go below a certain level to prevent camera shake. But when shooting a subject against a night scene, fast shutter speeds can make the background too dark. Slow synchronization allows you to capture both the background and the subject. Since the shutter speed is slow, be sure to stabilize the camera by using a tripod so as not to cause the picture to be blurred.

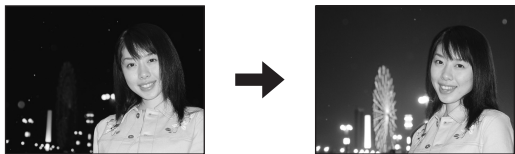
1st curtain

Usually, the flash fires right after the shutter fully opens. This is called 1st curtain. This method is usually used during flash shooting.

## Slow synchronization (2nd curtain) ⚡ SLOW2 / 2nd CURTAIN

2nd curtain flash fires just before the shutter closes. Changing the flash timing can create interesting effects in your picture, such as expressing the movement of a car by showing the tail-lights streaming backwards. The slower the shutter speed, the better the effects turn out. In **S / M** mode, the flash always fires.

When the shutter speed is set to 2 sec.

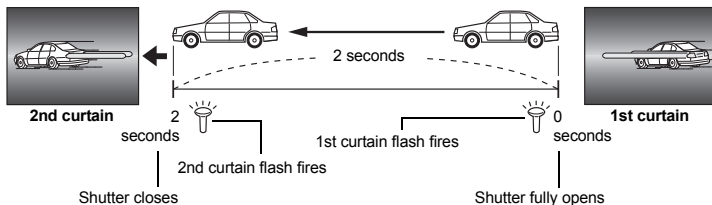

## Slow synchronization (1st curtain) / Red-eye reduction flash ⦿ SLOW

While using slow synchronization with flash shooting, you can also use this function to achieve red-eye reduction. When shooting a subject against a night scene, this function allows you to reduce the red-eye phenomenon. As the time from emitting pre-flashes to shooting is long in 2nd curtain synchronization, it is difficult to achieve red-eye reduction. Hence, only 1st curtain synchronization setting is available.

## Fill-in flash ⚡

The flash fires regardless of the light conditions. This mode is useful for eliminating shadows on the subject's face (such as shadows from tree leaves), in a backlight situation, or for correcting the color shift produced by artificial lighting (especially fluorescent light).



### ! Notes

- When the flash fires, the shutter speed is set to 1/180 sec. or less. When shooting a subject against a bright background with the fill-in flash, the background may be overexposed. In this case, use the optional FL-50R external flash or a similar flash and shoot in the Super FP flash mode. ⚡ "Super FP flash" (P. 75)

## Flash off ⏏

The flash does not fire.

Even in this mode, the flash can be used as an AF illuminator when it is raised.

⚡ "AF ILLUMINAT." (P. 87)

## Manual flash

This allows the built-in flash to output a fixed amount of light. To shoot with manual flash, set the f-number on the lens based on the distance to the subject.

Ratio of amount of light	GN: Guide number (Equivalent to ISO 100)
FULL (1/1)	12
1/4	6
1/16	3
1/64	1.5

Calculate the f-number on the lens using the following formula.

$$\text{Aperture (f-number)} = \frac{\text{GN} \times \text{ISO sensitivity}}{\text{Distance to the subject (m)}}$$

## ISO sensitivity

ISO value	100	200	400	800	1600
ISO sensitivity	1.0	1.4	2.0	2.8	4.0

## Setting method

**Direct button**



**Super control panel**

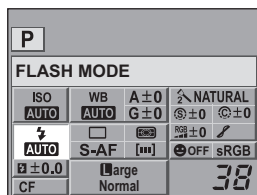
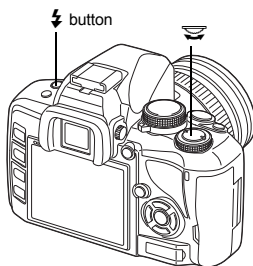

- Not all flash modes may be available depending on the shooting mode. For details refer to “Flash modes that can be set by shooting mode” (P. 124).













## Built-in flash shooting

If you shoot a subject using a lens that is wider than 14 mm (equivalent to 28 mm on a 35 mm film camera), the light emitted by the flash may produce a vignette effect. Whether or not vignetting occurs also depends on lens type and shooting conditions (such as distance to the subject).

### 1 Press the button to raise the built-in flash.

- The built-in flash will pop up automatically and fire in low light conditions under the following modes.

AUTO /  /  /  /  /  /  /  /  /  / 

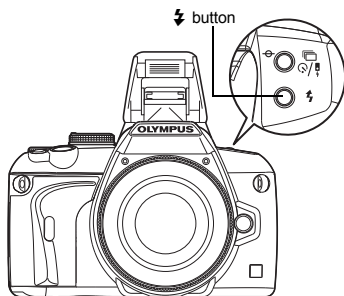

### 2 Press the shutter button halfway.

- The  (flash stand-by) mark lights when the flash is ready to fire. If the mark is blinking, the flash is charging. Wait until charging is complete.

### 3 Press the shutter button all the way.

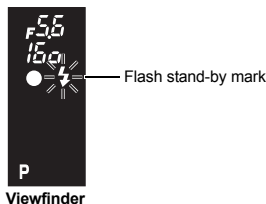



#### TIPS

**When you do not want the flash to pop up automatically:**

→ Set [AUTO POP UP] to [OFF].  "AUTO POP UP" (P. 92).

#### Notes

- When [ RC MODE] is set to [ON], the built-in flash will fire only to communicate with the external flash so it will not function as a flash.

 "Shooting with the Olympus wireless RC flash system" (P. 76)

## Flash intensity control

The flash intensity can be adjusted from +3 to -3.

In some situations (e.g., when shooting small subjects, distant backgrounds, etc.), you may get better results by adjusting the amount of light emitted by the flash ("flash intensity"). It is useful when you intend to increase the contrast (distinction between light and dark) of images to make the images more vivid.

### Direct button



### Super control panel



### Menu

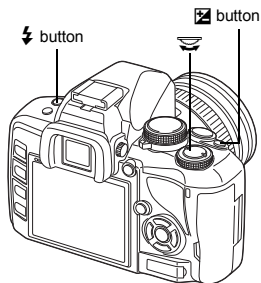

### Notes

- This does not work during manual flash.
- This does not work when the flash control mode on the electronic flash is set to MANUAL.
- If flash intensity is adjusted on the electronic flash, it will be combined with the camera's flash intensity setting.
- When [Flash Intensity] is set to [ON], the flash intensity value will be added to the exposure compensation value.  
 (P. 92)

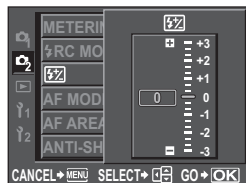

## 7

## External flash shooting

Flash shooting

In addition to the camera's built-in flash capabilities, you can use any of the external flash units specified for use with this camera. This enables you to take advantage of a wider variety of flash shooting techniques to suit different shooting conditions.

The external flashes communicate with the camera, allowing you to control the camera's flash modes with various available flash control modes, such as TTL-AUTO and Super FP flash. An external flash unit specified for use with this camera can be mounted on the camera by attaching it to the camera's hot shoe.

Refer to the external flash's manual as well.

### Functions available with external flash units

Optional flash	FL-50R	FL-50	FL-36R	FL-36	FL-20	RF-11	TF-22
Flash control mode	TTL-AUTO, AUTO, MANUAL, FP TTL AUTO, FP MANUAL				TTL-AUTO, AUTO, MANUAL	TTL-AUTO, MANUAL	
GN (Guide number) (ISO100)	GN50 (85 mm*) GN28 (24 mm*)		GN36 (85 mm*) GN20 (24 mm*)		GN20 (35 mm*)	GN11	GN22
RC mode	✓	—	✓	—	—	—	—

\* The focal length of the lens that can be used (Calculated based on 35 mm film camera)

### Notes

- The FL-40 optional flash cannot be used.

## Using the external electronic flash

Be sure to attach the flash to the camera before turning on the flash's power.

- 1 Remove the hot shoe cover by sliding it in the direction indicated by the arrow in the illustration.**

- Keep the shoe cover in a safe place to avoid losing it, and put it back on the camera after flash shooting.



- 2 Attach the electronic flash to the hot shoe on the camera.**

- If the lock pin is protruding, turn the shoe lock ring as far as it will go in the direction opposite to LOCK. This will pull the lock pin back inside.

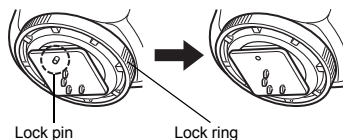

- 3 Turn on the flash.**

- When the charge lamp on the flash lights up, charging is complete.
- The flash will be synchronized with the camera at a speed of 1/180 sec. or less.

- 4 Select a flash mode.**

- 5 Select the flash control mode.**

- TTL-AUTO is recommended for normal use.

- 6 Press the shutter button halfway.**

- Shooting information such as ISO sensitivity, aperture value, and shutter speed is communicated between the camera and flash.

- 7 Press the shutter button all the way.**

### Notes

- The built-in flash cannot be used when an external flash is attached to the hot shoe.

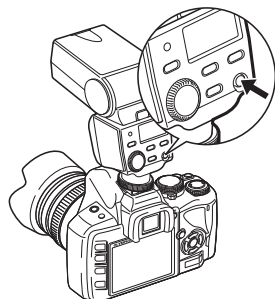

7

Flash shooting

## Super FP flash

Super FP flash is available with the FL-50R or FL-36R. Use the Super FP flash where normal flashes cannot be used with high shutter speed.

Fill-in flash shooting with the aperture open (such as in outdoor portrait shooting) is also possible with Super FP flash. For details, refer to the external flash's manual.

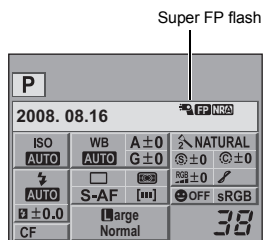

## Shooting with the Olympus wireless RC flash system

Wireless flash shooting is possible with the Olympus wireless RC flash system. With this wireless flash system, you can take pictures using multiple wireless flashes and control the flashes in three groups (A, B, and C). The built-in flash is used to communicate between the camera and the external flashes.

For details on using the wireless flash, see the manual of the external flash.

### Wireless flash setup range

Position the wireless flash so that the wireless sensor faces the camera. The setup range guidelines are as shown below. The range changes according to the surrounding environment.

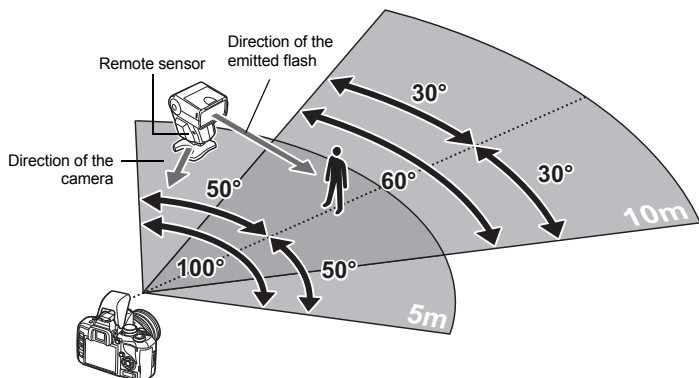

- 7** Flash shooting
- 1 Position the flash while referring to the “Wireless flash setup range”, and turn on the flash.
  - 2 Press the **MODE** button on the flash to set it to RC mode, and set the channel and group of the flash.
  - 3 Set RC mode on the camera to [ON].
    - **MENU** ▸ [**RC**] ▸ [**RC MODE**] ▸ [ON]
    - The super control panel switches to RC mode.
    - You can press the **INFO** button to switch the super control panel display.
  - 4 Use the super control panel to set the flash mode and other settings for each group.

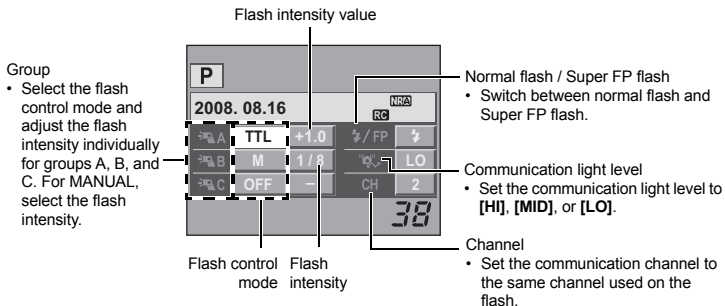

- 5 Select a flash mode.**
  - Red-eye reduction flash is not possible in RC mode.
- 6 Press the  button to raise the built-in flash.**
- 7 After shooting preparations are completed, take some test shots to check the flash operation and images.**
- 8 Begin shooting while checking the charging completed indications of the camera and flash.**

### Notes

- Although there is no limit to the number of wireless flashes you can use, it is recommended that each group have no more than three flashes to prevent flash malfunction due to mutual interference.
- In RC mode, the built-in flash is used to control the wireless flash. The built-in flash cannot be used for flash shooting in this mode.
- For 2nd curtain synchronization, set the shutter speed and anti-shock settings to within 4 seconds. Wireless flash shooting may not operate properly when using a slower shutter speed or anti-shock setting.

## Using commercially available flashes

You cannot use the camera to adjust the amount of light emitted from a commercially available flash except for a flash specified for use with this camera. To use a commercially available flash, connect it to the hot shoe. Set the camera's shooting mode to **M**.

- 1 Remove the hot shoe cover to connect the flash unit to the camera.**
- 2 Set the shooting mode to **M**, then set the aperture value and shutter speed.**
  - Set the shutter speed to 1/180 sec. or slower. If the shutter speed is faster than this, commercially available flashes cannot be used.
  - A slower shutter speed may produce blurred images.
- 3 Turn on the flash.**
  - Be sure to turn on the flash after attaching the flash unit to the camera.
- 4 Set the ISO sensitivity and aperture value on the camera to match the flash control mode on the flash.**
  - Refer to the flash's manual for instructions on how to set its flash control mode.

### Notes

- The flash fires each time the shutter is released. When you do not need to use the flash, turn off the flash's power.
- Check beforehand that the flash you are using is synchronized with the camera.

### Non-specified commercial flashes

- 1) Exposures when using a flash require that adjustments be made on the flash. If a flash is used in the auto mode, match it with the f-number and ISO sensitivity settings on the camera.
- 2) Even if the flash auto f-number and ISO sensitivity are set the same as on the camera, the correct exposure may not be obtained depending on the shooting conditions. In such a case, adjust the auto f-number or ISO on the flash or calculate the distance in the manual mode.
- 3) Use a flash with an illumination angle that matches the focal length of the lens. The focal length of the lens for 35 mm film is approximately twice as long as the focal length of the lenses designed for this camera.
- 4) Do not use a flash unit or other accessory TTL flash that has additional communication functions other than the specified flashes, since it may not only fail to function normally, but may also cause damage to the camera's circuitry.

## Single-frame / Close-up playback



The basic procedure for viewing pictures are as shown below.

However, before using any of these functions, follow Step 1 below. You can set the camera to automatically switch to single-frame playback mode after shooting. "REC VIEW" (P. 95)

### 1 Press the button (Single-frame playback).

- The last recorded image appears.
- The LCD monitor turns off after more than 1 minute if no operations are performed. The camera will turn off automatically if there is no operation after 4 hours. Turn on the camera again.

### 2 Use to select images you want to view. You can also turn the dial to switch to for close-up playback.

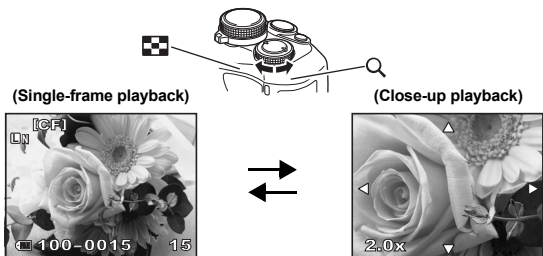
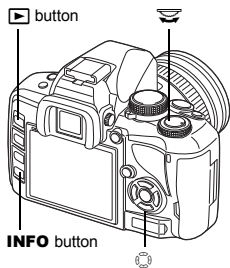

- : Displays the frame that is stored 10 frames back.
- : Displays the frame that is stored 10 frames ahead.
- : Displays the next frame.
- : Displays the previous frame.

Press the **INFO** button

### (Close-up position playback)



Press to change the close-up position.

Press to move the display of the close-up position. When **[FACE DETECT]** ( P. 41) is set to **[ON]**, a frame is displayed around a detected face. Press to move the frame to another face.

Press the **INFO** button

### (Close-up frame-by-frame playback)



Press to view frame-by-frame close-ups.

When **[FACE DETECT]** is set to **[ON]**, press to move to another face in close-up position.

- Press the **INFO** button to return to close-up playback.





- To exit the playback mode, press the button again.
- Pressing the shutter button halfway resumes the shooting mode.

## Index display / Calendar display



This function lets you show several images on the monitor at the same time. This is useful when you want to quickly search a number of pictures to find a particular image.

During single-frame playback, each time you turn the dial toward , the number of images shown changes between 4, 9, 16, 25, 49 and 100 pictures.

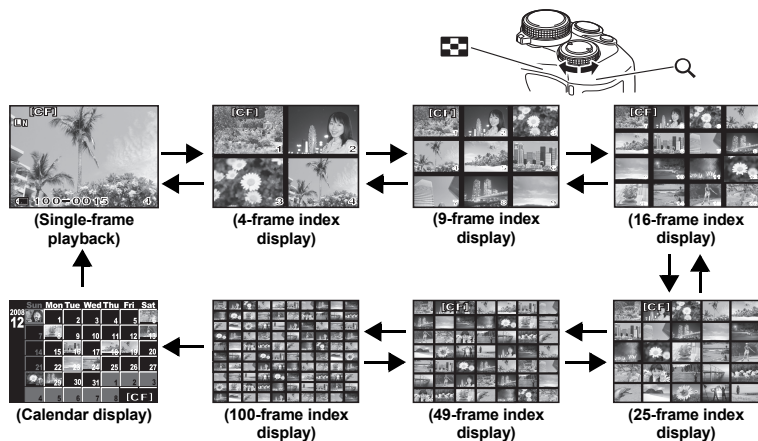
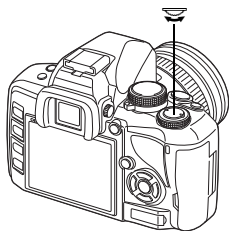

-  : Moves to the previous frame.
-  : Moves to the next frame.
-  : Moves to the upper frame.
-  : Moves to the lower frame.

- To return to single-frame playback, turn the control dial to Q.



### Calendar display

With the calendar, you can display images recorded on the card by date. If more than one image was taken on a single date, the image shot first on that date is displayed.

Use  to select a date and press the  button to play back images for the selected date in single-frame display.

## Information display

**INFO**

This allows you to display detailed information about the image. Luminance information can also be displayed with histogram and highlight graphs.

Press the **INFO** button repeatedly until the desired information is displayed.

- This setting is stored and will be shown the next time the information display is called up.

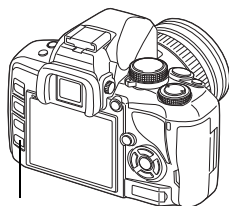

**INFO** button

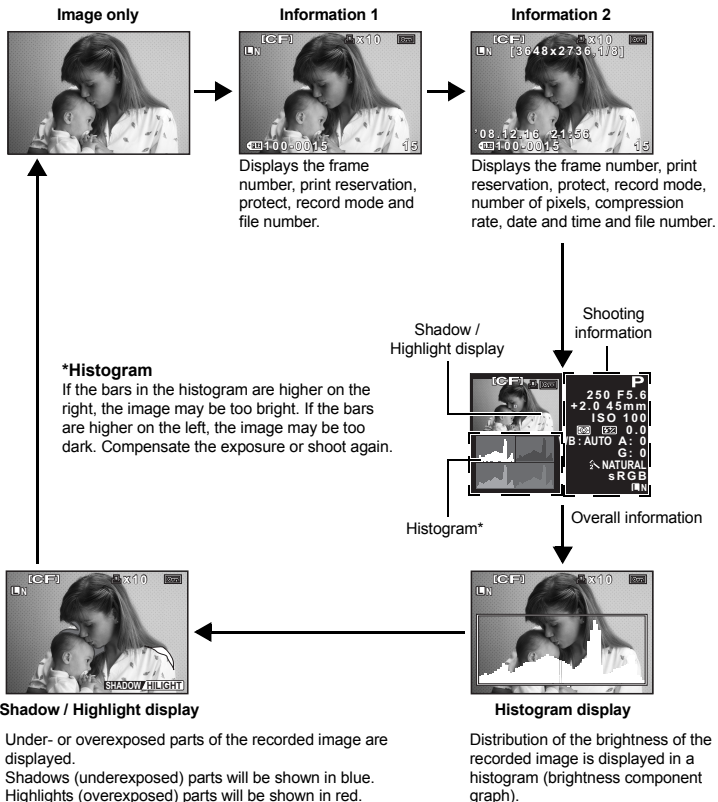



## Slideshow

This function displays images stored on the card one after another. Images are displayed one by one for about 5 seconds starting from the currently displayed image. Slideshow can be performed using index display. You can select the number of frames displayed during slideshow from 1, 4, 9, 16, 25, 49 or 100.

- 1 MENU** > [ ] > [ ]
- 2 Use** to set.  
[ ] **1** (1-frame display) / [ ] **4** (4-frame display) /  
[ ] **9** (9-frame display) / [ ] **16** (16-frame display) /  
[ ] **25** (25-frame display) / [ ] **49** (49-frame display) /  
[ ] **100** (100-frame display)
- 3 Press the** **button to start the slideshow.**
- 4 Press the** **button to stop the slideshow.**



When selecting [ ] **4**

### ! Notes

- If the slideshow is left running for about 30 minutes, the camera will turn off automatically.

## Rotating images

This function lets you rotate images and display them vertically on the monitor during single-frame playback. This is useful when taking pictures with the camera held vertically. The images will automatically be displayed in the correct direction even if the camera is rotated.

- 1 MENU** > [ ] > [ ]
  - When set to **[ON]**, images shot vertically will be automatically rotated and displayed during playback. You can also press the button to rotate and display the image.
  - The rotated image will be recorded on the card in that position.

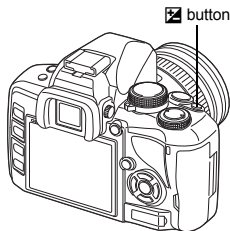

Original image before rotating

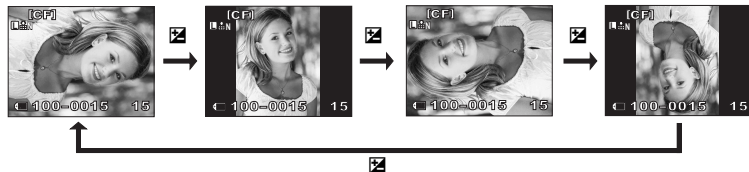

## Playback on TV

Use the video cable provided with the camera to play back recorded images on your TV.

- 1 Turn the camera and TV off, and connect the video cable as illustrated.
- 2 Turn on the TV and set it to the video input mode. For details on switching to the video input mode, refer to the TV's manual.
- 3 Turn the camera on and press the  (playback) button.

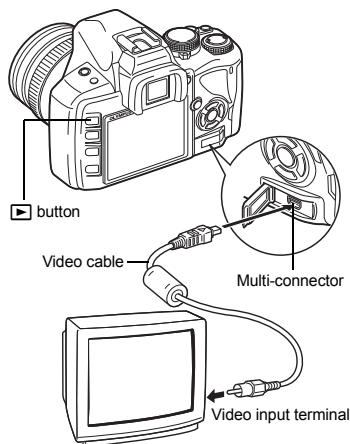

### Notes

- To connect the camera to a TV, use the provided video cable.
- Make sure that the camera's video output signal type is the same as the TV's video signal type.  "VIDEO OUT" (P. 95)
- The camera's monitor turns off automatically when the video cable is connected to the camera.
- The image may appear off-center depending on the TV screen.

## 8

## Editing still images

Recorded images can be edited and saved as new images. Available editing functions depend on the image format (image record mode).

A JPEG file can be printed as is without modification. A RAW file, on the other hand cannot be printed as is. To print a RAW file, use the RAW edit function to convert the RAW data format to JPEG.

### Editing images recorded in RAW data format

The camera performs image processing (such as white balance and sharpness adjustment) on images in the RAW data format, then saves the data to a new file in the JPEG format. While checking recorded images, you can edit them to your liking.

**Image processing is performed based on the current camera settings. Change the camera settings to suit your preferences before editing.**

## Editing images recorded in JPEG data format

- [SHADOW ADJ]** Brightens a dark backlit subject.
- [REDEYE FIX]** Reduces the red-eye phenomenon during flash shooting.  
Set the trimming size with the control dial and the trimming position with the arrow pad.

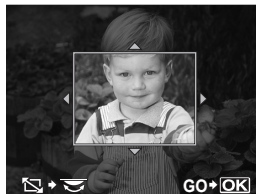

- [BLACK & WHITE]** Creates black and white images.
- [SEPIA]** Creates sepia-toned images.
- [SATURATION]** Sets the color depth. Adjust the color saturation checking the picture on the screen.
- [ ]** Converts the image file size to 1280 x 960, 640 x 480 or 320 x 240.

- 1 MENU** ▶ **[ ]** ▶ **[EDIT]**
- 2 Use** **[ ]** **to select an image, then press the** **[OK]** **button.**
  - The camera recognizes the image data format.
  - For images recorded in RAW+JPEG, a selection screen will appear, asking you which data to edit.
- 3 The setting screen varies with the image data format. Select the item you want to edit and do the following steps.**

Confirm the data format from here.

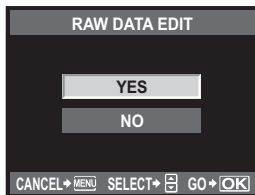
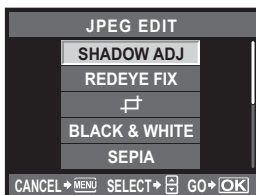





- The edited image is saved as another image, apart from the original image.
- To exit the edit mode, press the **MENU** button.

## ! Notes

- Red-eye correction may not work depending on the image. Red-eye correction may affect other parts of the image, as well as the eyes.
- Editing of a JPEG image is not possible in the following cases:
  - When an image is recorded in RAW, when an image is processed on a PC, when there is not enough space in the card memory, when an image is recorded on another camera
- When resizing (**[ ]**) an image, you cannot select a larger number of pixels than was originally recorded.

This function lets you copy images to and from the xD-Picture Card and CompactFlash or Microdrive. This menu can be selected if both cards are inserted. The selected card is the copying source.  "CF / xD" (P. 95)

## Single-frame copy





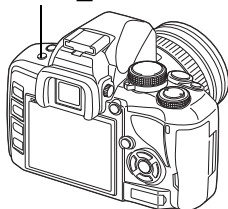



- 1 Play back the image you want to copy and press the **COPY** /  button.
- 2 Use   to select [YES], then press the  button.

**COPY** /  button





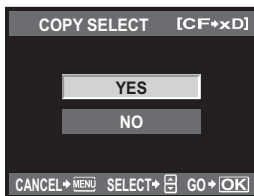

## Copying selected frames

This function lets you select multiple images and copy them all at the same time during single-frame playback or index display.

- 1 Display the images you want to copy and press the  button.
  - The selected images will be shown with red frames.
  - To cancel your selection, press the  button again.
- 2 Press  to display the next images you want to copy and press the  button.
- 3 After you have selected the images to copy, press the **COPY** /  button.
- 4 Use   to select [YES], then press the  button.



## Copying all the frames

- 1 MENU →  → [COPY ALL]
- 2 Press .
- 3 Use   to select [YES], then press the  button.

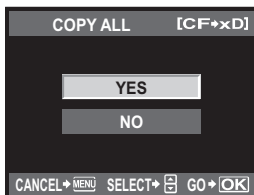

## Protecting images



Protect images you do not want to erase. Protected images cannot be erased by the single-frame or all-frame erase function.

### Single-frame protect

Play back the image you want to protect and press the **Ⓚ** button.

- **Ⓚ** (protect mark) is displayed on the top right corner of the screen.

#### To cancel the protection

Display the images that are protected and press the **Ⓚ** button.

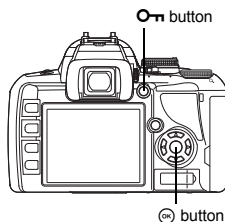

### Protecting selected frames

This function lets you select multiple images and protect them all at the same time during single-frame playback or index display.

- 1 Display the images you want to protect and press the **Ⓜ** button.**
  - The selected images will be shown with red frames.
  - To cancel your selection, press the **Ⓜ** button again.
  - During index display, press **Ⓜ** to select the images you want to protect and press the **Ⓜ** button.
- 2 Press **Ⓜ** to display the next images you want to protect and press the **Ⓜ** button.**
- 3 After you have selected the images to protect, press the **Ⓚ** button.**

### Canceling all protections

This function lets you cancel the protection of several images at one time.

- 1 MENU** > **[▶]** > **[RESET PROTECT]**
- 2 Use **⏪** **⏩** to select [YES], then press the **Ⓜ** button.**

#### **!** Notes

- Formatting the card erases all images even if they have been protected.  
🔧 “Formatting the card” (P. 118)
- Protected images cannot be rotated even when the **Ⓚ** button is pressed.

## Erasing images



Lets you erase recorded images. You can select single-frame erase, which erases only the currently displayed image; all-frame erase, which erases all the images stored on the card; or selected frame erase, which erases only the frames selected.

### Notes

- When you perform all-frame or selected frame erase on images recorded using RAW+JPEG, both the RAW and JPEG images are erased. When using single-frame erase, you can select whether to erase the JPEG, RAW, or both RAW and JPEG images.  
➤ "RAW+JPEG ERASE" (P. 94)
- Protected images cannot be erased. Cancel protected images, then erase them.
- Once erased, images cannot be restored. ➤ "Protecting images" (P. 85)

### Single-frame erase

- 1 Play back the image you want to erase and press the button.
- 2 Use to select [YES], then press the button.

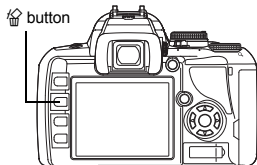

### Erasing selected frames

This function lets you erase selected images at one time during single-frame playback or index display.

- 1 Display the images you want to erase and press the button.
  - The selected images will be shown with red frames.
  - To cancel your selection, press the button again.
  - During index display, press to select the images you want to erase and press the button.
- 2 Press to display the next images you want to erase and press the button.
- 3 After you have selected the images to erase, press the button.
- 4 Use to select [YES], then press the button.

### All-frame erase

- 1 MENU  $\blacktriangleright$  [P.]  $\blacktriangleright$  [CARD SETUP]
- 2 Use to select [ALL ERASE], then press the button.
- 3 Use to select [YES], then press the button.
  - All frames will be erased.

Use the custom menus to customize the camera for ease of use. Use Custom Menu 1 to customize the shooting functions and Custom Menu 2 to set the basic camera functions. Custom Menu 1 has 8 tabs (iA to iH) that are divided according to the functions to be set.

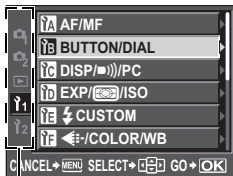

Use  $\odot$  to select [iA], then press  $\odot$ .

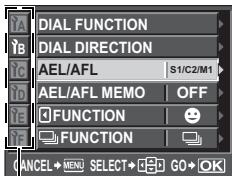

Use  $\odot$  to select tab iA to iH, then press  $\odot$ .

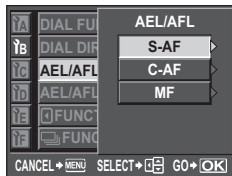

Use  $\odot$  to select a function, then press  $\odot$ .

For details on using the menu lists, see “Using the menu” (P. 29).

## Custom Menu 1 ▶ iA AF / MF

### AF ILLUMINAT.

The built-in flash can function as an AF illuminator. This helps with focusing in low-light conditions in the AF mode. To use this function, raise the flash.

### FOCUS RING

You can customize how the lens adjusts to the focal point by selecting the rotational direction of the focus ring.



### RESET LENS



When set to [ON], this resets the focus of the lens (infinity) each time the power is turned off.







### BULB FOCUSING

You can set the camera to enable focus adjustments during bulb shooting with MF.

- [ON] During exposure, you can turn the focus ring and adjust the focus.
- [OFF] The focus is locked during exposure.



**DIAL FUNCTION**

You can also switch the operation of the control dial to the opposite of factory default settings. For example, after setting [P] to , in P mode you can adjust the exposure compensation using the control dial and set the program shift using the control dial while holding down the  button.

Mode	Setting		 button + 
P	Ps (program shift)	Program shift	Exposure compensation
		Exposure compensation	Program shift
A	FNo.	Aperture value	Exposure compensation
		Exposure compensation	Aperture value
S	SHUTTER	Shutter speed	Exposure compensation
		Exposure compensation	Shutter speed
M	SHUTTER	Shutter speed	Aperture value
	FNo.	Aperture value	Shutter speed

**DIAL DIRECTION**

You can select the rotational direction of the control dial and the direction in which the shutter speed / aperture value will increase or decrease.

Setting	 (rotational direction of the dial)	 (rotational direction of the dial)
DIAL1	<ul style="list-style-type: none"> <li>• Slower shutter speed</li> <li>• Open the aperture (f-number is decreased)</li> </ul>	<ul style="list-style-type: none"> <li>• Faster shutter speed</li> <li>• Close the aperture (f-number is increased)</li> </ul>
DIAL2	<ul style="list-style-type: none"> <li>• Faster shutter speed</li> <li>• Close the aperture (f-number is increased)</li> </ul>	<ul style="list-style-type: none"> <li>• Slower shutter speed</li> <li>• Open the aperture (f-number is decreased)</li> </ul>



## AEL / AFL

You can use the **AEL / AFL** button to perform AF or metering operations instead of using the shutter button.

Select the function of the button to match the operation when the shutter button is pressed. Select **[mode1]** to **[mode4]** in each focus mode. (You can only select **[mode4]** in C-AF mode.)

Mode	Shutter button function				AEL / AFL button function	
	Half-press		Full press		When holding down AEL / AFL	
	Focus	Exposure	Focus	Exposure	Focus	Exposure
<b>[S-AF]</b>						
mode1	S-AF	Locked	—	—	—	Locked
mode2	S-AF	—	—	Locked	—	Locked
mode3	—	Locked	—	—	S-AF	—
<b>[C-AF]</b>						
mode1	C-AF start	Locked	Locked	—	—	Locked
mode2	C-AF start	—	Locked	Locked	—	Locked
mode3	—	Locked	Locked	—	C-AF start	—
mode4	—	—	Locked	Locked	C-AF start	—
<b>[MF]</b>						
mode1	—	Locked	—	—	—	Locked
mode2	—	—	—	Locked	—	Locked
mode3	—	Locked	—	—	S-AF	—

### Basic operations

- [mode1]** For determining the metered exposure while focusing. AE lock is activated while pressing the **AEL / AFL** button, allowing you to adjust the focus and determine the exposure separately.
- [mode2]** For determining the exposure when you press the shutter button fully. This is useful for shooting scenes with significant changes in lighting, such as on a stage.
- [mode3]** For focusing with the **AEL / AFL** button instead of the shutter button.
- [mode4]** Press the **AEL / AFL** button to focus, and press the shutter button fully to determine the exposure.

### AEL / AFL MEMO

You can lock and maintain the exposure by pressing the **AEL / AFL** button.

- [ON]** Press the **AEL / AFL** button to lock and maintain the exposure. Press again to cancel the maintaining of the exposure.
- [OFF]** The exposure will be locked only while the **AEL / AFL** button is pressed.

## FUNCTION

You can assign a function to the  button (**Fn** button).

### [Fn FACE DETECT]

Press the  button to set **[Fn FACE DETECT]** to **[ON]** and activate the optimal settings.

 "Using the face detection function" (P. 41), "FACE DETECT" (P. 91)

### [PREVIEW] / [LIVE PREVIEW] (electronic)

While holding down the  button, you can use the preview function.

 "Preview function" (P. 49)



Press the  button to acquire the WB value.

 "Setting the one-touch white balance" (P. 66)



### [TEST PICTURE]

Pressing the shutter button while pressing the  button enables you to check the picture you have just taken on the monitor without having to record the picture to the card. This is useful when you want to see how a picture turned out without saving it.

### [OFF]

Does not allow function allocation.

## FUNCTION

Other functions can be assigned to the  /  /  button.

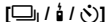

 "Sequential shooting" (P. 58), "Self-timer shooting" (P. 59), "Remote control shooting" (P. 60)

### [AF AREA]

 "AF target selection" (P. 56)

### [AF MODE]

 "AF mode selection" (P. 54)

### [WB]

 "Selecting the white balance" (P. 64)

### [METERING]

 "Changing the metering mode" (P. 50)

### [ISO]

 "ISO sensitivity setting" (P. 53)

## Custom Menu 1 ▶ DISP / / PC

## 9



You can turn off the beep sound that is emitted when the focus locks by pressing the shutter button.

### SLEEP

After a specified period of time elapses with no operations being performed, the camera enters the sleep mode (stand-by) to save battery power. After the super control panel is displayed for a specified period of time, the backlight turns off. After a specific period of time has further passed, the camera enters sleep mode. **[SLEEP]** lets you select sleep timer from **[1 MIN]**, **[3 MIN]**, **[5 MIN]**, or **[10 MIN]**. **[OFF]** cancels the sleep mode.

The camera activates again as soon as you touch any button (the shutter button,  button, etc.).

## BACKLIT LCD (Backlight timer)

To save battery power, after the super control panel is displayed for a specified period of time, the monitor backlight turns off and the monitor darkens. Select from **[8 SEC]**, **[30 SEC]**, or **[1 MIN]** for the time until the backlight turns off. **[HOLD]** sets the backlight to stay on. The monitor backlight turns on again as soon as you touch any button (the shutter button, arrow pad, etc.).

## USB MODE

You can connect the camera directly to a computer or printer with the provided USB cable. If you specify the device you are connecting to beforehand, you can skip the USB connection setting procedure normally required every time you connect the cable to the camera. For details on how to connect the camera to either device, refer to “Connecting the camera to a printer” (P. 99) and “Connecting the camera to a computer” (P. 103).

### [AUTO]

The selection screen for the USB connection will be displayed every time you connect the cable to a computer or printer.

### [STORAGE]

Allows you to transfer images to a computer. Also, select to use the OLYMPUS Master software via PC connection.

### [MTP]

Allows you to transfer images to a computer running Windows Vista without using the OLYMPUS Master software.

### [CONTROL]

Allows you to control the camera from a PC using the optional OLYMPUS Studio.

### [EASY]

Can be set when connecting the camera to a PictBridge-compatible printer. Pictures can be printed directly without using a PC.

“Connecting the camera to a printer” (P. 99)

### [CUSTOM]

Can be set when connecting the camera to a PictBridge-compatible printer. You can print out pictures with set number of prints, print paper and other settings.

“Connecting the camera to a printer” (P. 99)

## LIVE VIEW BOOST

During live view shooting, you can brighten the monitor for easier confirmation on the subject.

### [OFF]

The subject is displayed on the monitor with the brightness level that is adjusted according to the exposure being set. You can shoot while confirming through the monitor in advance to get a picture that is to your liking.

### [ON]

The camera automatically adjusts the brightness level and displays the subject on the monitor for easier confirmation. The effect of the exposure compensation adjustments will not be reflected on the monitor.

## FACE DETECT

When set to **[ON]**, the camera will detect people's faces and automatically adjust the focus there.

“Using the face detection function” (P. 41)

You can play back close-up images focusing on the subject's face.

“Single-frame / Close-up playback” (P. 78)

## FRAME ASSIST (Ruled lines display)

---

During live view, you can display the ruled lines on the LCD monitor as a guide when confirming the composition. Press the **INFO** button repeatedly to display the ruled lines.

 "Switching the information display" (P. 42)

## Custom Menu 1 ▶ EXP / / ISO

---

### ISO-AUTO SET

---

You can set the upper limit when ISO is set to **[AUTO]**.

This sets the upper limit of the ISO value that automatically changes. The upper limit can be set from 100 to 1600.

### ISO-AUTO

---

You can set the shooting mode in which the ISO **[AUTO]** setting is activated.

#### **[P / A / S]**

The **[AUTO]** setting is activated in all shooting modes except **M** mode. When **[AUTO]** is selected in **M** mode, ISO 100 is set.

#### **[ALL]**

The **[AUTO]** setting is activated for all shooting modes. The ISO is automatically selected to obtain the optimal ISO even in **M** mode.

### AEL Metering

---

You can set the metering mode when pressing the **AEL / AFL** button to lock the exposure.

- **[AUTO]** performs metering in the mode selected under **[METERING]**.

### BULB TIMER

---

You can select the maximum time (in minutes) for bulb shooting.

## Custom Menu 1 ▶ ⚡ CUSTOM

---



When set to **[ON]**, it will be added to the exposure compensation value and flash intensity control will be performed.

### AUTO POP UP

---

In **AUTO** or scene mode, the built-in flash pops up automatically in low light or backlight conditions. When set to **[OFF]**, the built-in flash will not pop up automatically.



## RAW+JPEG ERASE

You can select the method to erase images recorded in RAW+JPEG. This function can only be used to erase one frame.

- [JPEG]** Erases all JPEG image files, leaving only the RAW image files.
- [RAW]** Erases all RAW image files, leaving only the JPEG image files.
- [RAW+JPEG]** Erases both image file types.

### Notes

- This function is effective only if deleting one frame. For all-frame erase or erasing selected frames, both RAW and JPEG will be erased regardless of this setting.

## FILE NAME

When you take a picture, the camera assigns it a unique file name and saves it in a folder. File names are assigned as shown in the illustration below.

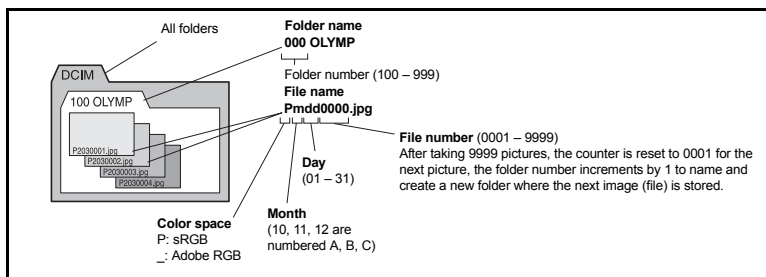

### [AUTO]

Even when a new card is inserted, the folder numbers are retained from the previous card. If the new card contains an image file whose file number coincides with one saved on the previous card, the new card's file numbers start at the number following the highest number on the previous card.

### [RESET]

When a new card is inserted, folder numbers start at 100 and file numbers start at 0001. If a card containing images is inserted, the file numbers start at the number following the highest file number on the card.

- When both the Folder and File No. reach their respective maximum number (999 / 9999), it is not possible to store additional pictures even if the card is not full. No more pictures can be taken. Replace the card with a new one.

## dpi SETTING

You can set the resolution for printing images in advance. The set value is recorded on the card with the images.

- [AUTO]** Automatically set according to the image size.
- [CUSTOM]** You can make the desired setting. Press **Fn** to display the setting screen.





## Custom Menu 2

### CF / xD

You can select which card to use when both a CompactFlash and xD-Picture Card are loaded.

#### (Monitor brightness adjustment)

You can adjust the brightness and color temperature of the monitor. Color temperature adjustment will affect only the LCD monitor display during playback.

Use  to switch between  (brightness) and  (color temperature), and use   to adjust the value between [+7] – [-7].



#### (Changing the display language)

You can change the language used for the on-screen display and error messages from ENGLISH to another language.

- You can add another language to your camera with the provided OLYMPUS Master software. For details, refer to Help in OLYMPUS Master software.

 "Using the OLYMPUS Master software" (P. 102)

### VIDEO OUT

You can select NTSC or PAL according to your TV's video signal type.

You will need to set this when you want to connect the camera to a TV and play back images in a foreign country. Make sure the correct video signal type is selected before connecting the video cable. If you use the wrong video signal type, recorded pictures will not play back properly on your TV.

#### TV video signal types in major countries and regions

Check the video signal type before connecting the camera to your TV.

NTSC	North America, Japan, Taiwan, Korea
PAL	European countries, China

### REC VIEW

You can display the picture you have just taken on the monitor while it is being recorded to the card, and to select how long the picture is displayed. This is useful for making a brief check of the picture you have just taken. Pressing the shutter button halfway while checking the picture lets you resume shooting immediately.

**[1SEC] – [20SEC]** Selects the number of seconds to display each picture. Can be set in units of 1 second.



**[OFF]** The picture being recorded to the card is not displayed.

**[AUTO ** Displays the image being recorded, and then switches to playback mode. This is useful for erasing a picture after checking it.

### FIRMWARE

Your product's firmware version will be displayed.

When you make inquiries about your camera or accessories or when you want to download software, you will need to state which version of each of the products you are using.

Press . Your product's firmware version will be displayed. Press the  button to return to the previous screen.

## Print reservation (DPOF)



### Print reservation

Print reservation allows you to save printing data (the number of prints and the date / time information) with the pictures stored on the card.

Pictures set with print reservation can be printed using the following methods.

#### Printing using a DPOF-compatible photo lab

You can print the pictures using the print reservation data.

#### Printing using a DPOF-compatible printer

Pictures can be printed directly from a dedicated printer without using a PC. For more details, refer to the printer's manual. A PC card adapter may also be necessary.

#### ! Notes

- DPOF reservations set by another device cannot be changed by this camera. Make changes using the original device. Moreover, setting new DPOF reservations using this camera will erase the previous reservations set by another device.
- Not all functions may be available on all printers or at all photo labs.
- RAW data are not printable.

### Single-frame reservation

Follow the operation guide to set print reservation for a picture.

#### 1 MENU > [ ] > [ ]



Operation guide

#### 2 Select [ ] and press the [ ] button.

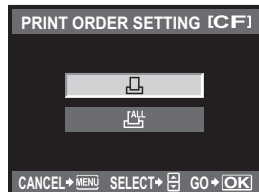



- 3** Press to select the frame that you want to set as print reservation, then press to set the number of prints.

- To set print reservation for several pictures, repeat this step.

- 4** Press the button when you have finished.

- The menu screen for single-frame reservation appears.

- 5** Select the date and time format and press the button.

[NO] The pictures are printed without the date and time.

[DATE] The pictures are printed with the shooting date.

[TIME] The pictures are printed with the shooting time.

- 6** Select [SET] and press the button.

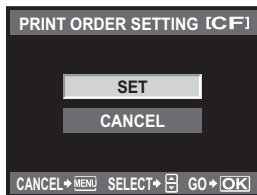
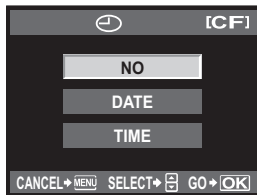

## All-frame reservation

Applies print reservation to all the pictures stored in the card. The number of prints is fixed at 1.

- 1** MENU  $\blacktriangleright$   $\blacktriangleright$
- 2** Select and press the button.
- 3** Select the date and time format and press the button.  
[NO] The pictures are printed without the date and time.  
[DATE] The pictures are printed with the shooting date.  
[TIME] The pictures are printed with the shooting time.
- 4** Select [SET] and press the button.

## Resetting the print reservation data

You can reset all print reservation data or just the data for selected pictures.

### 1 MENU ▸ [ ] ▸ [ ]

#### Resetting the print reservation data for all pictures

- 2 Select [ ] or [ ] and press the [ ] button.
- 3 Select [RESET] and press the [ ] button.



#### Resetting the print reservation data for a selected picture

- 2 Select [ ] and press the [ ] button.
- 3 Select [KEEP] and press the [ ] button.
- 4 Use [ ] to select the frame with print reservation data you want to reset, then press [ ] to set the number of prints to 0.
- 5 Press the [ ] button when you have finished.
- 6 Select the date and time format and press the [ ] button.
  - This setting is applied to all frames with print reservation data.
- 7 Select [SET] and press the [ ] button.

## Direct printing (PictBridge)



By connecting the camera to a PictBridge-compatible printer with the USB cable, you can print out recorded pictures directly. To find out if your printer is compatible with PictBridge, refer to the printer's manual.

### PictBridge

The standard that enables digital cameras and printers made by different manufacturers to be connected, and also allows pictures to be printed directly from the camera.

### STANDARD

All printers that support PictBridge have standard print settings. By selecting [STANDARD] on the settings screens ( [ ] P. 100), you can print pictures according to these settings. For details on your printer's standard settings, refer to the printer's manual or contact the printer manufacturer.

- The available print modes and settings such as paper size vary with the type of printer. For details, refer to the printer's manual.
- For details on printing paper types, ink cassettes, etc., refer to the printer's manual.

### Notes

- Use a fully charged battery for printing.
- Images recorded in RAW data cannot be printed.
- The camera will not enter sleep mode while it is connected to the USB cable.

## Connecting the camera to a printer

Use the provided USB cable to connect the camera to a PictBridge-compatible printer.

- 1 Turn the printer on and connect the camera's multi-connector to the printer's USB port with the USB cable.

- For details on how to turn the printer on and the position of the USB port, refer to the printer's manual.

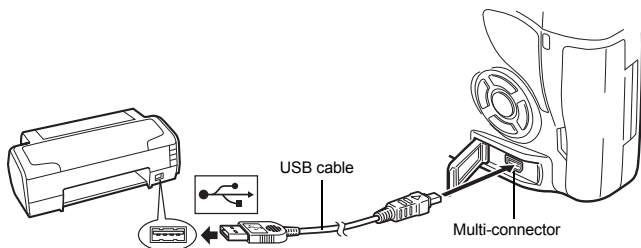

- 2 Turn on the camera.
  - The selection screen for the USB connection is displayed.
- 3 Use  to select [EASY PRINT] or [CUSTOM PRINT].

### If you select [EASY PRINT]

- Go to "Easy printing" ( P. 99)

### If you select [CUSTOM PRINT]

- [ONE MOMENT] is displayed and the camera and printer are connected.  
Go to "Custom printing" ( P. 100)

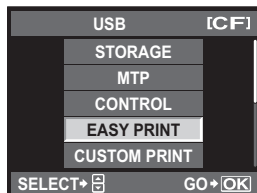

### ! Notes



- If the screen is not displayed after a few minutes, disconnect the USB Cable and start again from Step 1.

## Easy printing

- 1 Use  to display the pictures you want to print on the camera.

- Display the image you want to print on the camera and connect the camera with a printer using a USB cable. The screen on the right appears shortly.

- 2 Press the  (print) button.

- The picture selection screen appears when printing is completed. To print another picture, use  to select the image and press the  button.
- To exit, unplug the USB cable from the camera while the picture selection screen is displayed.

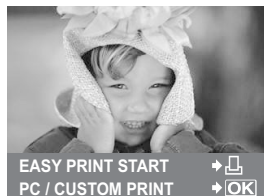

## 1 Follow the operation guide to set a print option.

### Selecting the print mode

Select the type of printing (print mode). The available print modes are as shown below.

- [PRINT]** Prints selected pictures.
- [ALL PRINT]** Prints all the pictures stored in the card and makes one print for each picture.
- [MULTI PRINT]** Prints multiple copies of one image in separate frames on a single sheet.
- [ALL INDEX]** Prints an index of all the pictures stored in the card.
- [PRINT ORDER]** Prints according to the print reservation you made. If there is no picture with print reservation, this is not available. (P. 97)

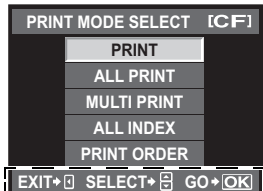

Follow the operation guide displayed here.

### Setting the print paper items

This setting varies with the type of printer. If only the printer's STANDARD setting is available, you cannot change the setting.

- [SIZE]** Sets the paper size that the printer supports.
- [BORDERLESS]** Selects whether the picture is printed on the entire page or inside a blank frame.
- [PICS / SHEET]** Selects the number of pictures per sheet. Displayed when you have selected **[MULTI PRINT]**.

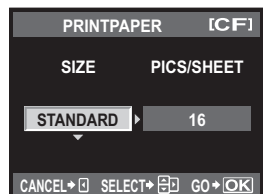
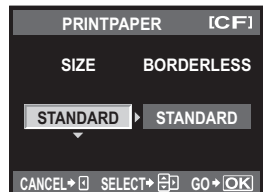

### Selecting pictures you want to print

Select pictures you want to print. The selected pictures can be printed later (single-frame reservation) or the picture you are displaying can be printed right away.

- [PRINT] (OK)** Prints the currently displayed picture. If there is a picture that **[SINGLE PRINT]** reservation has already been applied to, only that reserved picture will be printed.
- [SINGLE PRINT] (▲)** Applies print reservation to the currently displayed picture. If you want to apply reservation to other pictures after applying **[SINGLE PRINT]**, use (◀) to select them.
- [MORE] (▼)** Sets the number of prints and other items for the currently displayed picture, and whether or not to print it. For operation, refer to "Setting printing data" (P. 101) in the next section.



### Setting printing data

Select whether to print printing data such as the date and time or file name on the picture when printing.

- [x] Sets the number of prints.  
[DATE] Prints the date and time recorded on the picture.  
[FILE NAME] Prints the file name recorded on the picture.  
[] Trims the picture for printing. Set the trimming size with the control dial and the trimming position with the arrow pad.

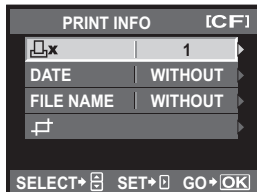

## 2 Once you have set the pictures for printing and printing data, select [PRINT], then press the button.

- [PRINT] Transfers images you print to the printer.  
[CANCEL] Resets the settings. All print reservation data will be lost. If you want to keep the print reservation data and make other settings, press . This returns you to the previous setting.

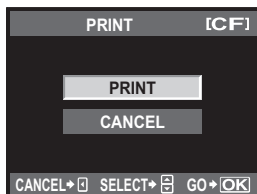

- To stop and cancel printing, press the button.

- [CONTINUE] Continues printing.  
[CANCEL] Cancels printing. All print reservation data will be lost.

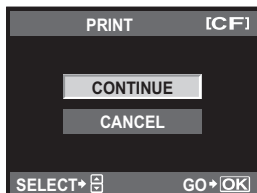

# 11 Using the OLYMPUS Master software

## Flowchart

Just connect the camera to a computer with the USB cable and you can easily transfer images stored on the card to the computer with the provided OLYMPUS Master software.

### Things to prepare

- OLYMPUS Master 2 CD-ROM
- USB cable
- Computer that fulfills the operating environment  
(For the required operating environment, refer to the OLYMPUS Master installation guide.)

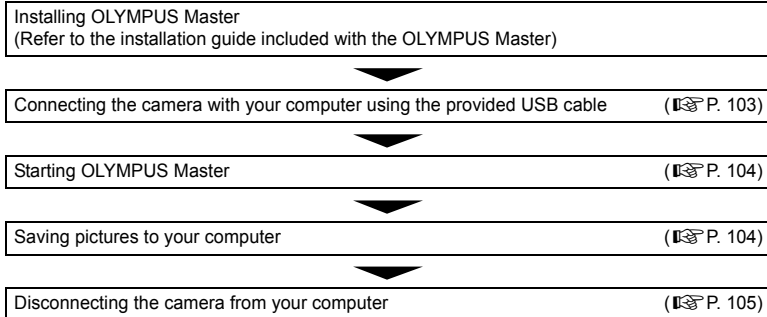

## Using the provided OLYMPUS Master software

### What is OLYMPUS Master?

OLYMPUS Master is an image management program with viewing and editing features for pictures taken with your digital camera. Once installed on your computer, you can take advantage of the following.

- **Transferring images from the camera or removable media to your computer**
- **Viewing images**  
You can also enjoy slideshows and sound playback.
- **Grouping and organizing images**  
You can organize images into albums or folders. Transferred images are automatically organized by shooting date, allowing you to quickly find the particular images you want.
- **Correcting images using filter and correction functions**
- **Editing images**  
You can rotate, trim or change the image size.
- **A variety of printing formats**  
You can easily make prints of your pictures.
- **Updating the camera firmware**
- **Developing RAW images**

For information about OLYMPUS Master's other features, as well as for details on how to use the software, refer to "Help" in OLYMPUS Master software.

## Connecting the camera to a computer

Connect the camera to your computer with the provided USB cable.

**1 Use the provided USB cable to connect the computer's USB port to the camera's multi-connector.**

- The location of the USB port varies with the computer. For details, refer to your computer's manual.

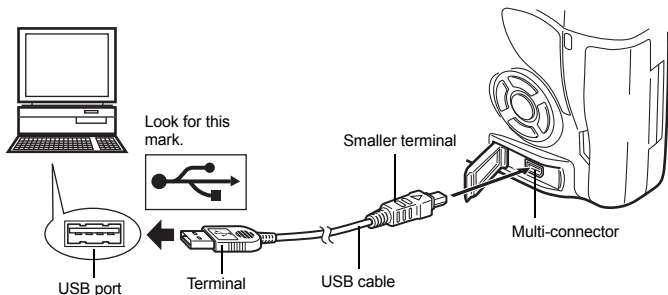

**2 Set the camera's power switch to ON.**

- The selection screen for the USB connection is displayed.

**3 Press  $\leftarrow$   $\rightarrow$  to select [STORAGE]. Press the  $\odot$  button.**

**4 The computer recognizes the camera as a new device.**

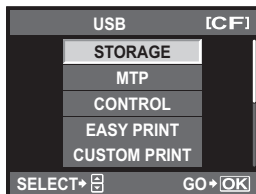

### Windows

- When you connect the camera to the computer for the first time, the computer automatically recognizes the camera. Click "OK" when the message saying that the installation is completed appears. The computer recognizes the camera as a "Removable Disk .

### Macintosh

- iPhoto is the default image management application for Mac OS. When you connect your Olympus digital camera for the first time, iPhoto will start up automatically. Close iPhoto and start OLYMPUS Master.

**! Notes**

- When the camera is connected to the computer, none of the camera buttons are functional.

## Start up the OLYMPUS Master software

### Windows

- 1 Double-click the “OLYMPUS Master 2” icon  on the desktop.

### Macintosh



- 1 Double-click the “OLYMPUS Master 2” icon  in the “OLYMPUS Master 2” folder.
  - The browse window is displayed.
  - When OLYMPUS Master is started up for the first time after installation, the OLYMPUS Master initial setting screen and user registration screen are displayed before the browse window. Follow the on-screen instructions.

### To exit OLYMPUS Master

- 1 Click “Exit”  on any window.
  - OLYMPUS Master is exited.

## Displaying camera images on a computer

### Downloading and saving images

- 1 Click “Transfer Images”  on the browse window, and then click “From Camera”  .
  - The window for selecting the pictures you want to transfer from the camera is displayed. All the images in the camera are displayed.
- 2 Select “New Album” and enter an album name.
- 3 Select the image files and click “Transfer Images”.
  - A window indicating that the download is complete is displayed.
- 4 Click “Browse images now”.
  - The downloaded images are displayed in the browse window.

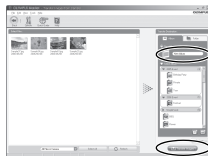



## Disconnecting the camera from your computer

- 1 Make sure that the card access lamp has stopped blinking.

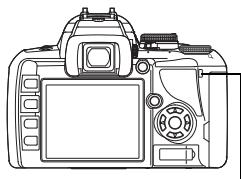

Card access lamp

- 2 Prepare to remove the USB cable.

### Windows

- 1) In the system tray, click the "Unplug or Eject Hardware" icon .
- 2) Click on the pop-up message.
- 3) Click "OK" on the "Safe to Remove Hardware" window.

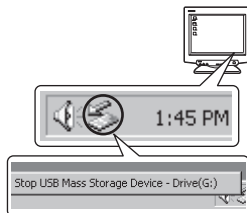

### Macintosh

- 1) The trash icon changes to the eject icon when the "Untitled" or "NO\_NAME" icon on the desktop is dragged. Drag and drop it on the eject icon.

- 3 Unplug the USB cable from the camera.

### Notes

- For Windows users:  
When you click "Unplug or Eject Hardware", a warning message may be displayed. In such case, make sure that no image data is being downloaded from the camera, and that there are no applications open that were accessing the camera image files. Close any such applications and click "Unplug or Eject Hardware" again and then remove the cable.



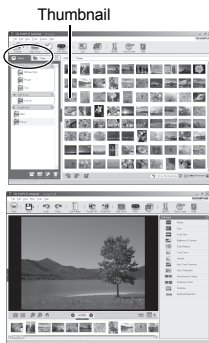

## Viewing still images

- 1 Click the “Album” tab on the browse window and select the album that you want to view.
  - The selected album image is displayed in the thumbnail area.
- 2 Double-click the still picture thumbnail that you want to view.
  - OLYMPUS Master switches to the image edit window and the picture is enlarged.
  - Click “Back”  to return to the browse window.



## To increase the number of languages

Please take care that your battery is fully charged!

- 1 Make sure that your computer is connected to the Internet.
- 2 Plug the USB cable into the USB port on the computer.
- 3 Plug the other end of the USB cable into the camera's multi-connector.
  - The camera turns on automatically.
  - The monitor turns on and the selection screen for the USB connection is displayed.
- 4 Select [STORAGE] and press the  button.
- 5 In the browse window, select “Camera”, then “Update Camera / Add Display Language”.
- 6 Click “OK”.
  - The updating the camera window is displayed.
- 7 Click “Add Language” in the updating camera display.
  - The “Add Display Language of Camera” window is displayed.
- 8 Click  and select a language.
- 9 Click “Add”.
  - The new language is downloaded to your camera.
  - Please do not remove any cable or the battery while the camera is processing.
- 10 After the download procedure the camera display will show “OK”. You can remove the cables and turn power off. After restarting the camera you will be able to choose the new language from .

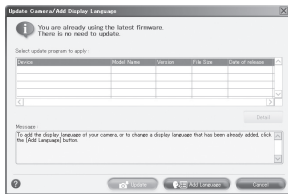

## Transferring images to your computer without using OLYMPUS Master

Your camera supports the USB Mass Storage Class. You can transfer images to a computer by connecting the camera to the computer with the provided USB cable. This can be done even without using OLYMPUS Master. The following operating systems are compatible with the USB connection:

Windows: 2000 Professional / XP Home Edition / XP Professional / Vista

Macintosh: Mac OS X v10.3 or later

### ! Notes

- If your computer is running Windows Vista, select **[MTP]** in Step 3 on page 103 to use Windows Photo Gallery.
- Data transfer is not guaranteed in the following environments, even if your computer is equipped with a USB port.
  - Computers with a USB port added by means of an extension card, etc.
  - Computers without a factory-installed OS and home-built computers.

## Shooting tips and information

### Tips before you start taking pictures

---

#### The camera does not turn on even when a battery is loaded

---

##### The battery is not fully charged

- Charge the battery with the charger.

##### The battery is temporarily unable to function because of the cold

- Battery performance declines in low temperatures, and the charge may not be sufficient to turn on the camera. Remove the battery and warm it by putting it in your pocket for a while.

#### No picture is taken when the shutter button is pressed

---

##### The camera has turned off automatically

- To save battery power, if there is no operation, the camera goes into sleep mode after a fixed period of time and the camera stops operating. The camera activates again when you touch the shutter button or any other button. The camera will turn off automatically if there is no further operation for 4 hours. The camera will not work until it is turned back on.  "SLEEP" (P. 90)

##### The flash is charging

- When the flash is raised, the  symbol blinking in the super control panel or the viewfinder indicates that the flash is charging. Wait for the blinking to stop, then press the shutter button.

##### Unable to focus

- When the AF confirmation mark in the viewfinder is blinking, it indicates that the camera is unable to focus using AF. Press the shutter button again.

##### Noise reduction is activated

- When shooting night scenes, shutter speeds are slower and noise tends to appear in images. The camera activates the noise-reduction process after shooting at slow shutter speeds. During which, shooting is not allowed. You can set [NOISE REDUCT.] to [OFF].  
 "Noise reduction" (P. 69)

#### The date and time has not been set

---

##### The camera is used with the settings at the time of purchase

- The date and time of the camera is not set when purchased. Set the date and time before using the camera.  "Setting the date / time" (P. 15)

##### The battery has been removed from the camera

- The date and time settings will be returned to the factory default settings if the camera is left without the battery for approximately 1 day. The settings will be canceled more quickly if the battery was only loaded in the camera for a short time before being removed. Before taking important pictures, check that the date and time settings are correct.

## Shooting tips

### Focusing on the subject

There are several ways to focus, depending on the subject.

#### AF target is not focused on the subject

- Use focus lock to focus the AF target on the subject.  
☞ "Focus lock – If correct focus cannot be obtained" (P. 57)

#### Other things instead of the subject are in focus on the respective AF targets

- Set [AF AREA] to [•] and focus on the center of the image. ☞ "AF target selection" (P. 56)

#### The subject is moving quickly

- Focus the camera on a point roughly the same distance away as the subject you want to shoot (by pressing the shutter button halfway), and then recompose your picture and wait for the subject to enter the frame.

#### Close up on the subject using macro lens

- When using macro lens to close up on the subject, it is difficult to focus with AF when the enlargement ratio of the subject is bigger. Set to manual focus (MF), rotate the focus ring and focus manually. ☞ "MF (manual focus)" (P. 55)

#### Taking pictures in low light conditions

- The built-in flash can be set to function as an AF illuminator. The flash helps to focus in low-light conditions in the AF mode when raised. ☞ "Built-in flash shooting" (P. 73), "AF ILLUMINAT." (P. 87)

### Subjects that are difficult to focus on

It may be difficult to focus with auto focus in the following situations.

AF confirmation mark is blinking.  
These subjects are not focused.



Subject with low contrast

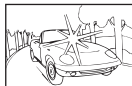

Excessively bright light  
in center of frame

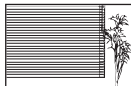

Subject with  
repeated patterns

AF confirmation mark  
lights up but the subject is  
not focused.



Subjects at different  
distances

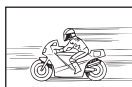

Fast-moving subject



Subject not inside  
AF area

In any situation, focus on something with high contrast that is at the same distance as the subject, determine the composition and shoot the picture.

### Taking pictures without blurring

There are several factors that can cause the picture to blur.

#### The subject is too dark

- Change the shutter speed to match the brightness of the subject. If the shutter speed is set low to shoot a dark subject, blurring is likely to occur if the subject moves. In addition, when the flash is turned off in **SCENE** (Scene mode), the shutter speed becomes slower.

Mount the camera on a tripod. Using the remote control (optional) to close the shutter is also effective for reducing blurring.

There are also ways to shoot with **[DIS]** (DIS MODE) under **SCENE** (Scene mode). As the ISO sensitivity increases automatically, you can hand hold the camera and take pictures in low light situations with the flash off.

### The camera or your hand moves when pressing the shutter button

- Press the shutter button gently or hold the camera securely with both hands.
- You can avoid camera movement while pressing the shutter button by using self-timer or anti-shock.  
📷 "Self-timer shooting" (P. 59), "Anti-shock" (P. 61)

### Taking pictures with less flash

---

When using auto flash, the flash will light up automatically when it is not bright enough and camera blur is more likely to occur. If the subject is too far away, the flash may have no effect. Here is how to take pictures without the flash in this type of situation.

#### Set **SCENE** (Scene mode) to **[DIS]** (DIS MODE)

- As the ISO sensitivity increases automatically, you can hand hold the camera and take pictures in low light situations with the flash off.

#### Increase the ISO setting

- Increase the value of the ISO setting. The image may become grainy.  
📷 "ISO sensitivity setting" (P. 53)

### The picture is too grainy

---

#### Increasing the ISO sensitivity

- When you increase the ISO setting, noise, which appears as spots of unwanted color or unevenness in the color, can be introduced and give the picture a grainy appearance. This camera is equipped with a function to allow shooting at high sensitivity while suppressing noise; however, increasing the ISO sensitivity creates grainier pictures than when using a lower sensitivity.  
📷 "ISO sensitivity setting" (P. 53)

### Image taken appears whitish

---

This may occur when the picture is taken in backlight or semi-backlight conditions. This is due to a phenomenon called flare or ghosting. As far as possible, consider a composition where strong light source is not taken in the picture. Flare may occur even when a light source is not present in the picture. Use a lens hood to shade the lens from the light source. If a lens hood does not have effect, use your hand to shade the lens from the light.

- 📷 "Interchangeable lenses" (P. 119)

### Taking pictures with the correct color

---

The reason why there are differences between the colors in a picture and the actual colors taken and the actual color is the light source illuminating the subject. **[WB]** is the function that allows the camera to determine the correct colors. Normally, the **[AUTO]** setting provides the optimal white balance, but depending on the subject, it may be better to experiment with changing the **[WB]** setting.



- When the subject is in the shade on a sunny day.
- When the subject is illuminated by both natural light and indoor lighting, such as when near a window.
- When there is no white in the frame.  
📷 "Selecting the white balance" (P. 64)

### Taking pictures of a white beach or snow scene

---





In normal cases, white subjects such as snow will appear darker than usual when the picture is taken. There are several ways to capture the whiteness.

- Adjust the exposure compensation toward **[+]**. 📷 "Exposure compensation" (P. 51)
- Use **[S]** (BEACH & SNOW) in **SCENE** (Scene mode) to take the picture. It is most suitable for taking pictures of the sea in a sunny day or snow-capped mountains.  
📷 "Mode dial" (P. 4)

- Use **[HI]** (Spot metering highlight control). Press the shutter button halfway at the center of the viewfinder where you wish to highlight the whiteness. The metered part at the center will be set to appear whiter.  “Changing the metering mode” (P. 50)
- Use the AE bracketing function to take the picture. If you do not know the amount of exposure compensation, try using AE bracketing. The compensation value changes a little every time you press the shutter button. If you set a larger exposure compensation, you can change the compensation value either upwards or downwards based on that value and shoot the picture.  “AE bracketing” (P. 52)

## Taking pictures of a subject against backlight

If the background is too bright compared to the subject, the exposure will be affected at the bright parts and the subject will appear darker. This is because the camera determines the exposure from the brightness of the whole screen.

- Set **[METERING]** to **[]** (spot metering) to measure the exposure of the subject in the center of the picture. To change the composition, place the subject in the center of the picture. While holding down the **AEL / AFL** button, change the composition and press the shutter button.  “Changing the metering mode” (P. 50)
- Activate the flash, set the flash mode to **[]** (fill-in flash) and shoot the picture. You can shoot a subject against backlight without the face of the subject appearing dark. **[]** (fill-in flash) is used for shooting against backlight and under fluorescent and other artificial lighting.  “Flash mode setting” (P. 70)

## Image turns out too bright or too dark

When taking pictures in **S** mode or **A** mode, the displayed shutter speed or aperture setting may blink. A blinking display means that the correct exposure cannot be obtained. If you take the picture as is, the picture will appear too bright or too dark. If that happens, change the aperture setting or shutter speed.

-  “Aperture priority shooting” (P. 46), “Shutter priority shooting” (P. 47), “Exposure warning display” (P. 123)

## Unknown bright dot(s) appear on the subject in the picture taken





This may be due to stuck pixel(s) on the image pickup device. Perform **[PIXEL MAPPING]**. If the problem persists, repeat pixel mapping a few times.

-  “Pixel mapping – Checking the image processing functions” (P. 117)

## Additional shooting tips and information

### Increasing the number of pictures that can be taken

The captured image will be recorded on the card. The following ways describe how to record more images.

- Change the record mode. The size of an image varies with the record mode. When you are not sure of the available card capacity, change the image mode and shoot the picture. The smaller the image size and the higher the compression, the smaller the size of the image becomes. To make the file size small, combine the image size and compression rate and register it with **[ SET]**. You can further reduce the number of pixels by setting **[PIXEL COUNT]** to fewer pixels for image size **[]** or **[]**.  “Selecting the record mode” (P. 62), “ SET” (P. 93), “PIXEL COUNT” (P. 93)
- Use a card with large capacity. The number of recordable images varies with the capacity of the card. Use a card with large capacity.

## Using a new card

If you use a non-Olympus card or a card used for another application, such as for a computer, the message **[CARD ERROR]** is displayed. To use this card with this camera, use the **[FORMAT]** function to format the card.  "Formatting the card" (P. 118)

## Extending the useful life of the battery

Performing any of the following operations when not actually taking pictures can deplete the battery power.

- Repeatedly pressing the shutter button halfway.
- Repeatedly playing back the captured images over a long period of time.
- Using the live view function over a long period.

To save battery power, turn off the camera whenever it is not in use.

## Functions that cannot be selected from menus

Some items may not be selectable from the menus when using the arrow pad.

- Items that cannot be set with the current shooting mode.
- Items that cannot be set because of an item that has already been set:
  - Combination of  and **[NOISE REDUCT.]**, etc.

## Cannot use the Imager AF

Imager AF is available only when using compatible lenses. For the latest information about Olympus lenses compatible with Imager AF, visit the Olympus website.

## Selecting the optimal record mode

Record modes are divided into 2 main types: RAW and JPEG. RAW records without reflecting the settings for white balance, contrast, etc. on the images themselves. JPEG records as images that reflect these settings. JPEG also compresses images to reduce the file size when recording them. For JPEG, you can register four combinations of images sizes (**L**, **M**, **S**) and compression rates (SF, F, N, B) from the 12 total combinations available. The higher the compression rate, the grainier the image will appear when enlarged during display. A rough guide for selection is shown below.

### To make fine-adjustments of the shooting settings on the computer

- **[RAW]**

### To print large images on A3 / A4 paper / To edit and process images on a computer

- Images size **L** and compression rate SF, F, N, or B

### To print postcard-size images

- Images size **M** and compression rate SF, F, N, or B

### To send as an e-mail attachment or post on a web site

- Images size **S** and compression rate SF, F, N, or B

 "Record mode and file size / number of storable still pictures" (P. 125)

## To restore functions to their settings at the time of purchase

- The settings are saved even when the power is switched off.
- To return to the factory default settings, set **[RESET]** under **[CUSTOM RESET]**. You can register up to two types of settings to be reset. Set various functions of the camera and register using **[RESET1]** or **[RESET2]** under **[CUSTOM RESET]**.

 "Resetting to the factory default settings" (P. 30)



## Confirming the exposure when it is difficult to view the monitor outdoors

The monitor may be difficult to view and the exposure difficult to confirm when shooting outdoors.

During live view, press the **INFO** button repeatedly to display the histogram.

The following shows you how to read the histogram display easily.

### How to read the histogram

- ① If the graph has many peaks around here, the image will appear mostly black.
- ② If the graph has many peaks around here, the image will appear mostly white.
- ③ The part indicated in green in the histogram shows the luminance distribution within the spot metering area.

 "Switching the information display" (P. 42)

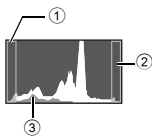

## Playback tips

### Understanding the settings and other information of pictures taken

Play back a picture, and press the **INFO** button. Press the button repeatedly to change the amount of information displayed.  "Information display" (P. 80)

## Viewing pictures on a computer

### Viewing the entire picture on a computer screen

The size of the picture displayed on a computer screen changes depending on the computer settings. When the monitor setting is 1024 x 768 and you are using Internet Explorer to view a picture with an image size of 2048 x 1536 at 100 %, the entire picture cannot be viewed without scrolling. There are several ways you can view the entire picture on the computer screen.

#### View the picture using image browsing software

- Install the OLYMPUS Master software from the provided CD-ROM.











#### Change the monitor setting











- The icons on the computer desktop may be rearranged. For details of changing the settings on your computer, refer to the computer's manual.



### To view recorded images in RAW

Install the OLYMPUS Master software from the provided CD-ROM. You can use the RAW development function in OLYMPUS Master to develop the RAW image in the camera setting used during shooting, as well as change detailed settings such as white balance and contrast.

## Error codes

Viewfinder indications	Monitor indication	Possible cause	Corrective action
Normal indication	 NO CARD	The card is not inserted, or it cannot be recognized.	Insert a card or insert a different card.
	 CARD ERROR	There is a problem with the card.	Insert the card again. If the problem persists, format the card. If the card cannot be formatted, it cannot be used.
	 WRITE PROTECT	Writing to the card is prohibited.	The card has been set to read-only setting with the computer. Reset the card with the computer.
No indication	 CARD FULL	The card is full. No more pictures can be taken or no more information such as print reservation can be recorded.	Replace the card or erase unwanted pictures. Before erasing, download important images to a PC.
		There is no space in the card and print reservation or new images cannot be recorded.	Replace the card or erase unwanted pictures. Before erasing, download important images to a PC.
No indication		xD-Picture Cards cannot be read or is not formatted.	<ul style="list-style-type: none"> <li>• Select <b>[xD CARD CLEAN]</b>, press the  button and turn off the camera. Remove the card and wipe dry the metallic surface with a soft, dry cloth.</li> <li>• Select <b>[FORMAT] ▶ [YES]</b>, and then press the  button to format the card. Formatting the card erases all data on the card.</li> </ul>
No indication	 NO PICTURE	There are no pictures on the card.	The card contains no pictures. Record pictures and play back.

Viewfinder indications	Monitor indication	Possible cause	Corrective action
No indication	 PICTURE ERROR	The selected picture cannot be displayed for playback due to a problem with this picture. Or the picture cannot be used for playback on this camera.	Use image processing software to view the picture on a PC. If that cannot be done, the image file is damaged.
No indication	 THE IMAGE CANNOT BE EDITED	Pictures taken with another camera cannot be edited on this camera.	Use image processing software to edit the picture.
No indication	 Internal camera temperature is too high. Please wait for cooling before camera use.	Extended use of live view or sequential shooting has increased the internal temperature of the camera.	Wait a moment for the camera to turn off automatically. Allow the internal temperature of the camera to cool before resuming operations.
	 CARD-COVER OPEN	The card cover is open.	Close the card cover.
No indication	 BATTERY EMPTY	The battery is drained.	Charge the battery.
No indication	 NO CONNECTION	The camera is not connected to the computer or printer correctly.	Disconnect the camera and connect it again correctly.
No indication	 NO PAPER	There is no paper in the printer.	Load some paper in the printer.
No indication	 NO INK	The printer has run out of ink.	Replace the ink cartridge in the printer.
No indication	 JAMMED	The paper is jammed.	Remove the jammed paper.
No indication	SETTINGS CHANGED	The printer's paper cassette has been removed or the printer has been manipulated while making settings on the camera.	Do not manipulate the printer while making settings on the camera.

Viewfinder indications	Monitor indication	Possible cause	Corrective action
No indication	 PRINT ERROR	There is a problem with the printer and / or camera.	Turn off camera and printer. Check the printer and remedy any problems before turning the power on again.
No indication	 CANNOT PRINT	Pictures recorded on other cameras may not be printed on this camera.	Use a personal computer to print.

## Camera maintenance

### Cleaning and storing the camera

#### Cleaning the camera

Turn off the camera and remove the battery before cleaning the camera.

#### **Exterior:**

- Wipe gently with a soft cloth. If the camera is very dirty, soak the cloth in mild soapy water and wring well. Wipe the camera with the damp cloth and then dry it with a dry cloth. If you have used the camera at the beach, use a cloth soaked in clean water and well wrung.

#### **Monitor and viewfinder:**

- Wipe gently with a soft cloth.

#### **Lens, mirror and focusing screen:**

- Blow dust off the lens, mirror and focusing screen with a commercially available blower. For the lens, wipe gently with a lens cleaning paper.

#### **Storage**

- When not using the camera for a prolonged period, remove the battery and card. Store the camera in a cool, dry place that is well ventilated.
- Insert the battery periodically and test the camera's functions.

#### **Cleaning and checking the image pickup device**

This camera incorporates a dust reduction function to keep dust from getting on the image pickup device and to remove any dust or dirt from the image pickup device surface with ultrasonic vibrations. Dust reduction is activated when the power switch is set to ON and when starting and stopping live view. The dust reduction function operates at the same time as the pixel mapping, which checks the image pickup device and image processing circuitry. Since dust reduction is activated every time the camera's power is turned on, the camera should be held upright for the dust reduction function to be effective. The SSWF indicator blinks while dust reduction is working.  "SSWF indicator" (P. 14)

#### **! Notes**



- Do not use strong solvents such as benzene or alcohol, or a chemically treated cloth.
- Avoid storing the camera in places where chemicals are treated, in order to protect the camera from corrosion.
- Mold may form on the lens surface if the lens is left dirty.
- Check each part of the camera before use if it has not been used for a long time. Before taking important pictures, be sure to take a test shot and check that the camera works properly.

## Cleaning mode – Removing dust

If dust or dirt gets on the image pickup device, black dots may appear in the picture. Contact your Olympus Authorized Service Center to have the image pickup device physically cleaned. The image pickup device is a precision device and is easily damaged. When cleaning the image pickup device yourself, be sure to follow the instructions below. If power runs out during cleaning, the shutter will close, which may cause the shutter curtain and mirror to break. Keep an eye on the remaining battery power.

**1** Remove the lens from the camera, and set the power switch to ON.

**2** MENU ▸ [1] ▸ [i] ▸ [CLEANING MODE]

**3** Press , then press the  button.

- The camera enters the cleaning mode.

**4** Press the shutter button all the way.

- The mirror goes up and the shutter curtain opens.

**5** Clean the image pickup device.

- Carefully blow off any dust on the surface of the image pickup device by using a mechanical blower (commercially available).

**6** Be careful not to catch the mechanical blower in the shutter curtain when turning the power off to finish cleaning.

- If the camera turns off, the shutter curtain closes, causing the mirror to fall.

### ! Notes

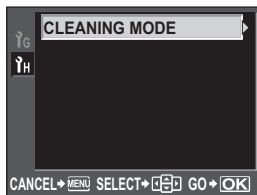

- Be careful not to let the mechanical blower (commercially available) touch the image pickup device. If the blower touches the image pickup device, the image pickup device will be damaged.
- Never put the mechanical blower behind the lens mount. If the power turns off, the shutter closes, breaking the shutter curtain.
- Do not use anything other than the mechanical blower. If high-pressure gas is sprayed onto the image pickup device, it will freeze on the image pickup device's surface, damaging the image pickup device.



## Pixel mapping – Checking the image processing functions

The pixel mapping feature allows the camera to check and adjust the image pickup device and image processing functions. After using the monitor or taking continuous shots, wait for at least one minute before using the pixel mapping function to ensure that it operates correctly.

**1** MENU ▸ [2] ▸ [PIXEL MAPPING]

**2** Press , then press the  button.

- The [BUSY] bar is displayed when pixel mapping is in progress. When pixel mapping is finished, the menu is restored.

### ! Notes

- If you accidentally turn the camera off during pixel mapping, start again from Step 1.

## Card basics

### Usable cards

"Card" in this manual refers to a recording medium. This camera can use CompactFlash, Microdrive or xD-Picture Card (optional).

#### CompactFlash

A CompactFlash is a large-capacity solid state flash memory card. You can use commercially available cards.

#### Microdrive

A Microdrive is a medium that uses a large-capacity compact hard disk drive. You can use a Microdrive that supports CF+Type II (CompactFlash extension standard).

#### xD-Picture Card

An xD-Picture Card is a recording medium used mainly in compact cameras.

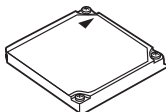
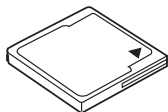

### Precautions when using a Microdrive

A Microdrive is a medium that uses a compact hard disk drive. Because the disk drive rotates, a Microdrive is not as resistant to vibration or impact as other cards. Special care is needed when using a Microdrive (especially during recording and playback) to make sure the camera is not subjected to shock or vibrations. Be sure to read the following precautions before using a Microdrive.

Also, refer to the manuals provided with your Microdrive.

- Be very careful when putting the camera down during recording. Place it gently on a firm surface.
- Do not use the camera in places subject to vibrations or excessive shock, such as at a construction site or in a car while driving along a bumpy road.
- Do not take a Microdrive close to areas where it may be exposed to strong magnetism.
- The Microdrive may not function correctly under low air pressure conditions, like in altitudes of 3,000 m (9,843 ft.) and higher.



#### Notes

- The data in the card will not be erased completely even after formatting the card or deleting the data. When discarding, destroy the card to prevent leakage of personal information.

### Formatting the card

Non-Olympus cards or cards formatted on a computer must be formatted with the camera before they can be used.

All data stored on the card, including protected images, is erased when the card is formatted. When formatting a used card, confirm there are no images that you still want to keep on the card.

- 1 MENU ▸ [C] ▸ [CARD SETUP]
- 2 Use to select [FORMAT], then press the button.
- 3 Use to select [YES], then press the button.
  - Formatting is performed.

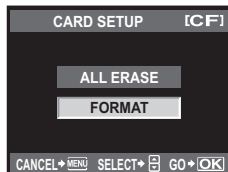

#### TIPS

#### When inserting cards into the two card slots:

→ Select the card to be used in [CF / xD]. "CF / xD" (P. 95)

## Battery and charger

- Use the single Olympus lithium-ion battery (BLS-1). Other batteries cannot be used.
- The camera's power consumption varies widely with usage and other conditions.
- As the following consume a lot of power even without shooting, the battery will be drained quickly.
  - Performing auto focus repeatedly by pressing the shutter button halfway in shooting mode.
  - Using live view.
  - Displaying images on the LCD monitor for a prolonged period.
  - When connected to a computer or printer.
- When using a drained battery, the camera may turn off without the low battery warning being displayed.
- The battery will not be fully charged at the time of purchase. Charge the battery using the designated charger (BCS-1) before use.
- The normal charging time of the provided rechargeable battery is approximately 3 hours 30 minutes (estimated).
- Do not use chargers other than the one designated.

## Using your charger abroad

- The charger can be used in most home electrical sources within the range of 100 V to 240 V AC (50 / 60 Hz) around the world. However, depending on the country or area you are in, the AC wall outlet may be shaped differently and the charger may require a plug adapter to match the wall outlet. For details, ask at your local electrical shop or travel agent.
- Do not use commercially available travel adaptors as the charger may malfunction.

## Interchangeable lenses

Select the lens that you want to shoot with.

Use a specified Four Thirds lens (Four Thirds mount). When a non-specified lens is used, auto focus and light metering will not function correctly. In some cases, other functions may not work either.

### Four Thirds mount

Developed by Olympus as the lens mount standard for the Four Thirds system. These all-new interchangeable lenses featuring the Four Thirds mount were developed from the ground up based on optic engineering exclusively for digital cameras.

## ZUIKO DIGITAL interchangeable lens

Four Thirds system interchangeable lens are designed to withstand rigorous professional use. The Four Thirds system makes it possible for a fast lens to be compact and lightweight as well.

### Focal length and depth of field of Four Thirds system lenses

When compared to 35-mm cameras, Four Thirds system cameras achieve different effects at the same focal length and aperture.

#### Focal length

At the same focal length of a 35-mm camera, a Four Thirds system camera can achieve a focal length equivalent to twice that of a 35-mm camera. This enables the design of compact telephoto lenses. A 14 – 50 mm Four Thirds system lens, for example, is equivalent to a 28 – 100 mm lens for a 35-mm camera.

- When the image angle of Four Thirds system lens is converted to that of a 35-mm camera, the perspective is the same as that of a 35-mm camera.

#### Depth of Field

A Four Thirds system camera can achieve a depth of field equivalent to two times deeper than that of a 35-mm camera. This enables more light to enter through the aperture. A Four Thirds system lens with f2.0 brightness, for example, is equivalent to f4.0 when converted to the aperture of a 35-mm camera.

- You can achieve the same amount of background blur as if you were using a 35-mm camera.

#### Notes

- When you attach or remove the body cap and lens from the camera, keep the lens mount on the camera pointed downward. This helps prevent dust and other foreign matter from getting inside the camera.
- Do not remove the body cap or attach the lens in dusty places.
- Do not point the lens attached to the camera toward the sun. This may cause the camera to malfunction or even ignite due to the magnifying effect of sunlight focusing through the lens.
- Be careful not to lose the body cap and rear cap.
- Attach the body cap to the camera to prevent dust from getting inside when no lens is attached.

## ZUIKO DIGITAL lens specifications

### Names of parts

- ① Hood mount section
- ② Filter mount thread
- ③ Zoom ring
- ④ Focus ring
- ⑤ Mount index
- ⑥ Electrical contacts
- ⑦ Front cap
- ⑧ Rear cap
- ⑨ Lens hood

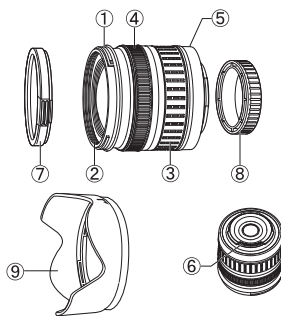



### ■ Attaching the hood

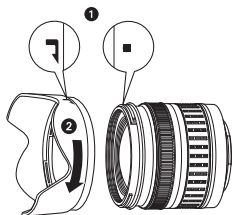

### ■ Storing the hood

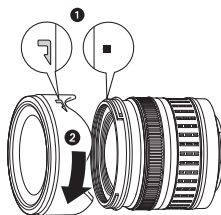

- Use the hood when shooting a backlit subject.
- The lens hood cannot be attached to the 17.5 – 45 mm lens.

### ■ Main Specifications

Items	17.5 – 45 mm	14 – 42 mm	40 – 150 mm	25 mm
Mount	FOUR THIRDS mount			
Focal length	17.5 – 45 mm	14 – 42 mm	40 – 150 mm	25 mm
Max. aperture	f3.5 – 5.6	f3.5 – 5.6	f4.0 – 5.6	f2.8
Image angle	63° – 27°	75° – 29°	30° – 8.2°	47°
Lens configuration	7 groups, 7 lenses	8 groups, 10 lenses	9 groups, 12 lenses	4 groups, 5 lenses
	Multilayer film coating (partially single layered)			
Iris control	f3.5 – 22	f3.5 – 22	f4.0 – 22	f2.8 – 22
Shooting range	0.28 m – ∞	0.25 m – ∞	0.9 m – ∞	0.2 m – ∞
Focus adjustment	AF / MF switching			
Weight (excluding hood and cap)	210 g	190 g	220 g	95 g
Dimensions (Max. diameter x overall length)	Ø 71 x 70 mm	Ø 65.5 x 61 mm	Ø 65.5 x 72 mm	Ø 64 x 23.5 mm
Lens hood mount	—	Bayonet		Screw-in type
Filter mount thread diameter	52 mm	58 mm		43 mm

Can be used with the optional EX-25 extension tube under the following conditions.  
The focus adjustment when EX-25 is used will be MF.

Lens, focal length		Shooting range	Magnification ( ): Calculated based on 35 mm film camera
17.5 – 45 mm	17.5 mm	Shooting is not possible since subjects cannot be brought into focus at this focal length.	
	28 mm	15.1 cm – 15.9 cm	0.89 – 1.16x (1.78 – 2.32x)
	45 mm	18.4 cm – 22.4 cm	0.57 – 0.91x (1.14 – 1.82x)
14 – 42 mm	14 mm	Shooting is not possible since subjects cannot be brought into focus at this focal length.	
	25 mm	13.3 cm	1.02x (2.04x)
	42 mm	16.2 cm – 17.3 cm	0.61 – 0.69x (1.22 – 1.38x)
40 – 150 mm	40 mm	19.0 cm – 20.4 cm	0.61 – 0.70x (1.22 – 1.40x)
	80 mm	28.0 cm – 40.6 cm	0.32 – 0.48x (0.64 – 0.96x)
	150 mm	48.0 cm – 118.8 cm	0.17 – 0.39x (0.34 – 0.78x)
25 mm	25 mm	11.1 cm – 11.2 cm	0.98 – 1.17x (1.96 – 2.34x)

### ■ Storage Precautions

- Clean the lens after use. Remove dust and dirt on the surface of the lens with a blower brush or brush. Use commercially available lens cleaning paper to remove the dirt on the lens. Do not use organic solvents.
- Always cap the lens and store it when it is not used.
- Do not store in an area with insect repellent.

### ❗ Notes on Shooting

- Edges of pictures may be cut off if more than one filter is used or if a thick filter is used.

## Program line diagram (P mode)

In the **P** mode, the camera is programmed such that the aperture value and shutter speed are automatically selected according to the subject's brightness as shown below. The program line diagram varies with the type of lens mounted.

— When using the  
14 – 42 mm  
f3.5 – 5.6 zoom lens  
(focal length: 14 mm,  
ISO100)

— Program shift

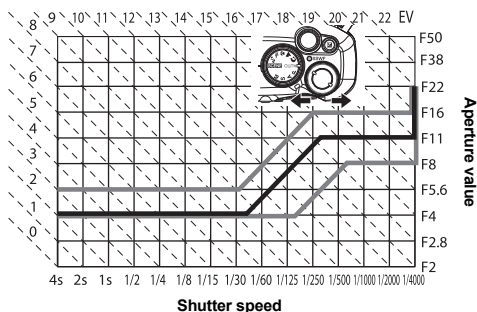





























## Exposure warning display

If the optimum exposure cannot be obtained when pressing the shutter button halfway, the display will blink in the viewfinder and on the super control panel.



Shooting mode	Warning display example (blinking)	Status	Action
P		The subject is too dark.	<ul style="list-style-type: none"> <li>• Increase the ISO sensitivity.</li> <li>• Use the flash.</li> </ul>
		The subject is too bright.	<ul style="list-style-type: none"> <li>• Decrease the ISO sensitivity.</li> <li>• Use a commercially available ND filter (for adjusting the amount of light).</li> </ul>
A		The subject is underexposed.	<ul style="list-style-type: none"> <li>• Decrease the aperture value.</li> <li>• Increase the ISO sensitivity.</li> </ul>
		The subject is overexposed.	<ul style="list-style-type: none"> <li>• Increase the aperture value.</li> <li>• Decrease the ISO sensitivity or use a commercially available ND filter (for adjusting the amount of light).</li> </ul>
S		The subject is underexposed.	<ul style="list-style-type: none"> <li>• Set the shutter speed slower.</li> <li>• Increase the ISO sensitivity.</li> </ul>
		The subject is overexposed.	<ul style="list-style-type: none"> <li>• Set the shutter speed faster.</li> <li>• Decrease the ISO sensitivity or use a commercially available ND filter (for adjusting the amount of light).</li> </ul>

\* The aperture value at the moment when its indication blinks varies with the lens type and focal length of the lens.

## Flash modes that can be set by shooting mode

Shooting mode	Super control panel screen display	Flash mode	Conditions to timing	Conditions to fire the flash	Shutter speed restrictions	
<b>AUTO</b>  <b>P</b>  <b>A</b>          	 <b>AUTO</b>	Auto flash	1st curtain	Fires automatically in dark / backlit* <sup>1</sup> conditions	1/60 sec. – 1/180 sec.	
		Auto flash (red-eye reduction)				
		Fill-in flash		Always fires	60 sec. – 1/180 sec.	
			Flash off	—	—	—
		 <b>SLOW</b>	Slow synchronization (red-eye reduction)	1st curtain	Fires automatically in dark / backlit* <sup>1</sup> conditions	60 sec. – 1/180 sec.
		 <b>SLOW</b>	Slow synchronization (1st curtain)			
		 <b>SLOW2</b>	Slow synchronization (2nd curtain)	2nd curtain		
		 <b>FULL</b>	Manual flash (FULL)	1st curtain	Always fires	
		 1/4	Manual flash (1/4)			
		 1/16	Manual flash (1/16)			
	 1/64	Manual flash (1/64)				
		Fill-in flash				
<b>S</b>  <b>M</b>	 	Fill-in flash (red-eye reduction)	—	—	—	
		Flash off	—	—	—	
		2nd CURTAIN	Fill-in flash / Slow synchronization (2nd curtain)	2nd curtain	Always fires	60 sec. – 1/180 sec.
<b>S</b>  <b>M</b>	 <b>FULL</b>	Manual flash (FULL)	1st curtain			
	 1/4	Manual flash (1/4)				
	 1/16	Manual flash (1/16)				
	 1/64	Manual flash (1/64)				

\*1 When the flash is set to the Super FP mode, it detects backlight with longer duration than for normal flash before emitting light.  “Super FP flash” (P. 75)

\*2 **AUTO**, ,  cannot be set in NIGHT+PORTRAIT mode.

## White balance color temperature

The higher the color temperature, the richer the light in bluish tones and the poorer in reddish; the lower the color temperature, the richer the light in reddish tones and the poorer in bluish. The spectral balance of different white light sources is rated numerically by color temperature – concept of physics expressed using the Kelvin (K) temperature scale. The color of sunlight and other natural light sources and the color of a light bulb and other artificial light sources can be expressed in terms of color temperature.

It follows, then, that the color temperatures of fluorescent lights make them unsuitable as artificial light sources. There are gaps in the hues from the color temperatures of fluorescent light. If these differences in hue are small, they can be calculated with color temperature and this is called correlated color temperature.

The 4000 K, 4500 K and 6600 K preset settings in this camera are correlated color temperatures, and should not be considered strictly as color temperatures. Use these settings for shooting conditions under fluorescent lights.

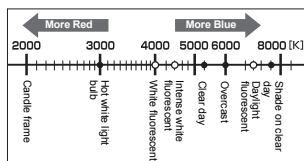

- The color temperatures for each light source indicated in the above scale are approximate.

## Record mode and file size / number of storable still pictures

The file size in the table is approximate.

Record mode	Number of pixels (PIXEL COUNT)	Compression	File format	File size (MB)	Number of storable still pictures (with 1 GB xD-Picture Card)
RAW	3648 x 2736	Loss-less compression	ORF	Approx. 11	91
SF		1/2.7		Approx. 6.8	147
F		1/4		Approx. 4.7	211
N		1/8		Approx. 2.2	460
B		1/12		Approx. 1.5	687
SF	3200 x 2400	1/2.7		Approx. 5.3	187
F		1/4		Approx. 3.7	267
N		1/8		Approx. 1.7	597
B		1/12		Approx. 1.1	888
SF		2560 x 1920		1/2.7	Approx. 3.6
F	1/4			Approx. 2.2	466
N	1/8			Approx. 1.1	927
B	1/12			Approx. 0.7	1361
SF	1600 x 1200			1/2.7	Approx. 1.3
F		1/4		Approx. 0.8	1163
N		1/8		Approx. 0.5	2284
B		1/12		Approx. 0.3	3198
SF		1280 x 960		1/2.7	Approx. 0.8
F	1/4			Approx. 0.5	1776
N	1/8			Approx. 0.3	3366
B	1/12		Approx. 0.2	4920	

Record mode	Number of pixels (PIXEL COUNT)	Compression	File format	File size (MB)	Number of storable still pictures (with 1 GB xD-Picture Card)
SF	1024 x 768	1/2.7	JPEG	Approx. 0.5	1881
F		1/4		Approx. 0.4	2665
N		1/8		Approx. 0.2	4920
B		1/12		Approx. 0.1	7107
SF	640 x 480	1/2.7		Approx. 0.2	4569
F		1/4		Approx. 0.2	6396
N		1/8		Approx. 0.1	10661
B		1/12		Approx. 0.1	12793

### Notes

- The number of remaining pictures may change according to the subject or factors like whether print reservations have been made or not. In certain instances, the number of remaining pictures displayed on the viewfinder or the LCD monitor does not change even when you take pictures or stored images are erased.
- The actual file size varies according to the subject.
- The maximum number of storable still pictures displayed on the monitor is 9999.

## Functions that can be registered in Custom Reset Settings

Function	Custom reset setting registration	Function	Custom reset setting registration
Shooting mode	—	SLEEP	✓
	✓	BACKLIT LCD	✓
	✓	USB MODE	—
AF MODE	✓	LIVE VIEW BOOST	✓
AF AREA	✓	FACE DETECT	✓
AE BKT	✓	FRAME ASSIST	✓
PICTURE MODE	✓	ISO-AUTO SET	✓
GRADATION	✓	ISO-AUTO	✓
	✓	AEL Metering	✓
NOISE REDUCT.	✓	BULB TIMER	✓
WB	✓		✓
	✓	AUTO POP UP	✓
METERING	✓	ALL	—
ISO	✓	COLOR SPACE	✓
NOISE FILTER	✓	SET	✓
Flash mode	✓	PIXEL COUNT	✓
	✓	RAW+JPEG ERASE	✓
	✓	FILE NAME	—
AF ILLUMINAT.	✓	dpi SETTING	—
FOCUS RING	✓	CLEANING MODE	—
RESET LENS	—		—
BULB FOCUSING	—	CF / xD	—
LIVE VIEW AF MODE	✓		—
DIAL FUNCTION	✓		—
DIAL DIRECTION	✓		—

AEL / AFL	✓	VIDEO OUT	—
AEL / AFL MEMO	✓	REC VIEW	✓
FUNCTION	✓	PIXEL MAPPING	—
FUNCTION	✓	FIRMWARE	—

✓: Can be registered. —: Cannot be registered.

\* Includes anti-shock.

## Menu directory

### Shooting Menu

Tab	Function	Setting	Ref. page	
	CARD SETUP	ALL ERASE / FORMAT	P. 86, 118	
	CUSTOM RESET	RESET		P. 30
		RESET1	SET / RESET	
		RESET2	SET / RESET	
	PICTURE MODE	VIVID /  NATURAL* /  MUTED /  PORTRAIT / MONOTONE		P. 67
	GRADATION	AUTO / NORMAL* / HIGH KEY / LOW KEY		P. 68
		RAW /  F /  N* /  M /  S / RAW+ F / RAW+ N / RAW+ M / RAW+ S		P. 62
	WB	AUTO*	A -7 - +7, G -7 - +7	P. 64
		5300 K	A -7 - +7, G -7 - +7	
		7500 K	A -7 - +7, G -7 - +7	
		6000 K	A -7 - +7, G -7 - +7	
		3000 K	A -7 - +7, G -7 - +7	
		4000 K	A -7 - +7, G -7 - +7	
		4500 K	A -7 - +7, G -7 - +7	
6600 K		A -7 - +7, G -7 - +7		
5500 K		A -7 - +7, G -7 - +7		
	CWB	2000 K - 14000 K		
ISO	AUTO* / 100 - 1600		P. 53	
NOISE REDUCT.	OFF / ON / AUTO*		P. 69	
NOISE FILTER	OFF / LOW / STANDARD* / HIGH		P. 69	
	METERING	*	ESP + AF / ESP*	P. 50
	RC MODE	OFF* / ON		P. 76
		-3.0 - 0.0* - +3.0		P. 74
	AF MODE	S-AF* / C-AF / MF / S-AF+MF / C-AF+MF		P. 54
	AF AREA	AUTO* /  ] / [  / [  ]		P. 56
	ANTI-SHOCK	OFF* / 1 SEC - 30 SEC		P. 61
AE BKT	OFF* / 3 F 0.3 EV / 3 F 0.7 EV / 3 F 1.0 EV		P. 52	

\* Factory default setting

## Playback Menu

Tab	Function	Setting	Ref. page	
▶		/  /  /  /  /  /	P. 81	
		OFF / ON*	P. 81	
	EDIT	RAW DATA EDIT		P. 82
		JPEG EDIT	SHADOW ADJ / REDEYE FIX /  / BLACK & WHITE / SEPIA / SATURATION /	
		/		P. 96
	COPY ALL	YES / NO		P. 84
	RESET PROTECT	YES / NO		P. 85

\* Factory default setting

## Custom Menu 1

Tab	Function	Setting	Ref. page	
11	AF / MF		P. 87	
	AF ILLUMINAT.	OFF / ON*	P. 87	
	FOCUS RING	* /	P. 87	
	RESET LENS	OFF / ON*	P. 87	
	BULB FOCUSING	OFF / ON*	P. 87	
	LIVE VIEW AF MODE	AF SENSOR / HYBRID AF / IMAGER AF*	P. 39	
	BUTTON / DIAL		P. 88	
	DIAL FUNCTION	<b>P</b>	<b>Ps*</b> /	P. 88
		<b>A</b>	FNo.* /	
		<b>S</b>	SHUTTER* /	
		<b>M</b>	SHUTTER / FNo.*	
	DIAL DIRECTION	DIAL1* / DIAL2	P. 88	
	AEL / AFL	S-AF*	mode1* / mode2 / mode3	P. 89
		C-AF	mode1 / mode2* / mode3 / mode4	
		MF	mode1* / mode2 / mode3	
	AEL / AFL MEMO	OFF* / ON	P. 89	
	FUNCTION	Fn FACE DETECT* / PREVIEW / OFF /  / LIVE PREVIEW / TEST PICTURE	P. 90	
	FUNCTION	/  * /  * / AF AREA / AF MODE / WB / METERING / ISO	P. 90	
	DISP /  / PC		P. 90	
		OFF / ON*	P. 90	
	SLEEP	OFF / 1 MIN* / 3 MIN / 5 MIN / 10 MIN	P. 90	
BACKLIT LCD	8 SEC* / 30 SEC / 1 MIN / HOLD	P. 91		
USB MODE	AUTO* / STORAGE / MTP / CONTROL /  EASY /  CUSTOM	P. 91		
LIVE VIEW BOOST	OFF* / ON	P. 91		
FACE DETECT	OFF* / ON	P. 41		
		P. 91		
FRAME ASSIST	OFF* / GRID / GOLDEN SECTION / SCALE	P. 92		

\* Factory default setting



Tab	Function	Setting	Ref. page	
11	EXP /  / ISO		P. 92	
	ISO-AUTO SET	100 – 1600 (400*)	P. 92	
	ISO-AUTO	<b>P / A / S*</b> / ALL	P. 92	
	AEL Metering	AUTO* /  /  /  /	P. 92	
	BULB TIMER	—	P. 92	
	CUSTOM		P. 92	
	+	OFF* / ON	P. 92	
	AUTO POP UP	OFF / ON*	P. 92	
	/ COLOR / WB		P. 93	
	ALL	ALL SET	A –7 – +7 G –7 – +7	P. 93
		ALL RESET	YES / NO	
	COLOR SPACE	sRGB* / AdobeRGB	P. 93	
	SET	1 –  4	/  /  SF / F / N / B	P. 93
	PIXEL COUNT	iddle	3200 x 2400 / 2560 x 1920* / 1600 x 1200	P. 93
		mall	1280 x 960* / 1024 x 768 / 640 x 480	
	RECORD / ERASE		P. 94	
	RAW+JPEG ERASE	JPEG / RAW / RAW+JPEG*	P. 94	
	FILE NAME	AUTO* / RESET	P. 94	
	dpi SETTING	AUTO* / CUSTOM	P. 94	
	UTILITY		P. 117	
	CLEANING MODE	—	P. 117	

\* Factory default setting

## Custom Menu 2

Tab	Function	Setting	Ref. page
12		—	P. 15
	CF / xD	CF* / xD	P. 95
		–7 – +7  –7 – +7	P. 95
		*1	P. 95
	VIDEO OUT	*1	P. 95
	REC VIEW	OFF / AUTO  / 1 SEC – 20 SEC (5 SEC*)	P. 95
	PIXEL MAPPING	—	P. 117
	FIRMWARE	—	P. 95

\* Factory default setting

\*1 Settings differ depending on the region where the camera is purchased.

## Glossary

### **A (Aperture Priority) Mode**

You set the aperture yourself and the camera automatically varies the shutter speed so that the picture is taken with the correct exposure.

### **AE (Automatic Exposure)**

The camera's built-in exposure meter automatically sets the exposure. The 3 AE modes available on this camera are **P** mode, in which the camera selects both the aperture and shutter speed, **A** mode, in which the user selects the aperture and the camera sets the shutter speed, and **S** mode, in which the user selects the shutter speed and the camera sets the aperture. In **M** mode, the user selects both the aperture and the shutter speed.

### **Aperture**

The adjustable lens opening which controls the amount of light that enters the camera. The larger the aperture, the shorter the depth of field and the fuzzier the background. The smaller the aperture, the greater the depth of field and the sharper the background. Aperture is measured in *f* / stops. Larger aperture values indicate smaller apertures, and smaller aperture values indicate larger apertures.

### **AUTO mode**

Program AE mode (see "**P** (Program) Mode"). In addition, this mode features automatic flash pop up when shooting in low-light conditions.

### **Center weighted averaging metering**

A light metering mode or technique that uses an average of the center and periphery of the image area but is biased toward the information at the center of the image area. This method is best used when the brightness of the center and periphery of the image area does not vary greatly. See also digital ESP metering and spot metering.

### **Color space**

A model that describes colors using more than three coordinates. Color spaces such as sRGB, Adobe RGB are occasionally used for encoding / reproducing colors.

### **Color temperature**

The spectral balance of different white light sources is rated numerically by color temperature – a concept of theoretical physics that, with incandescent lighting, corresponds roughly to the absolute lamp filament temperature, expressed on the Kelvin (K) temperature scale. The higher the color temperature, the richer the light in bluish tones and the poorer in reddish; the lower the color temperature, the richer the light in reddish tones and the poorer in bluish. You may encounter difficulties with color reproduction when shooting indoors under fluorescent lighting, or where sunlight and fluorescent lighting are both present. Your camera is provided with a white balance adjustment feature that you can use to compensate for the odd effects of combinations of color you may occasionally see in your pictures.

### **Compression rate**

Compression is a method of reducing file size by abbreviating some contents of data, and compression rate denotes the amount of compression. The actual effect of the selected compression rate could vary with the content of the image. The numbers for the compression rate selected with this camera provide only a general scale for reference and are not precise measurements.

### **DCF (Design rule for Camera File system)**

A standard for image files by the Japan Electronics and Information Technology Industries Association (JEITA).

### **Depth of Field**

Depth of Field refers to the distance from the nearest to the furthest point of perceived "sharp" focus in a picture.

### **Digital ESP (Electro-Selective Pattern) Light Metering**

This determines the exposure by splitting the image into 49 areas and metering and calculating the light levels in each area.

### **DPOF (Digital Print Order Format)**

This is for saving desired print settings on digital cameras. By entering which images to print and the number of copies of each, the user can easily have the desired images printed by a printer or print lab that supports the DPOF format.

### **Eclipsing (Vignetting)**

This refers to when an object obscures part of the field of view so that the whole subject is not photographed. Vignetting also refers to when the image seen through the viewfinder does not exactly match the image shot through the objective lens, so the photographed image includes objects not seen through the viewfinder. In addition, vignetting can occur when an incorrect lens hood is used, causing shadowing to appear in the corners of the image.

### **EV (Exposure Value)**

A system for measuring exposure. EV 0 is when the aperture is at F1 and the shutter speed is 1 second. The EV then increases by 1 each time the aperture increases by one F stop or the shutter speed increases by one increment. EV can also be used to indicate brightness and ISO settings.

### **Exposure**

The amount of light used to capture an image. The exposure is determined by the length of time the shutter is open (shutter speed) and the amount of light that passes through the lens (aperture).

### **Image pickup device**

This converts light passing through the lens into electrical signals. On this camera, light is picked up and converted into RGB signals to build a single image.

### **Imager contrast detection system**

Focusing method based on the contrast of the image of the subject captured on the image pickup device.

### **ISO**

International abbreviation for International Organization for Standardization. The sensitivity setting used in digital cameras is based on the same ISO standard used for film sensitivity. The sensitivity is denoted as shown in "ISO 100". Higher ISO values indicate greater sensitivity to light, so images can be exposed even in low-light conditions.

### **JPEG (Joint Photographic Experts Group)**

A compression format for color still images. Photographs (images) shot using this camera are recorded onto the card in JPEG format when the Record mode is set to a setting other than [RAW]. By downloading these images to a personal computer, users can edit them using graphics application software or view the images using an Internet web browser.

### **M (Manual) Mode**

The user sets both the aperture and shutter speed.

### **NTSC (National Television Systems Committee) / PAL (Phase Alternating Line)**

Television formats. NTSC is mainly used in Japan, North America and Korea. PAL is mainly used in Europe and China.

### **Number of pixels (PIXEL COUNT)**

The number of dots (pixels) used to create an image denotes the image size. For instance, an image in 640 x 480 pixel count is the same size as the computer screen if the monitor setting is also 640 x 480. If the monitor setting is 1024 x 768, the image only takes up part of the screen.

### **P (Program) Mode**

Also called Program AE mode. The camera automatically sets the best shutter speed and aperture for the shot.

**PictBridge**

A standard that enables digital cameras and printers made by different manufacturers to be connected, and also allows pictures to be printed directly from the camera.

**Pixels**

A pixel is the smallest unit (dot) used to make up an image. Clear large-sized printed images require millions of pixels.

**RAW**

Refers to raw data, data which has not been enhanced with a camera option like white balance, sharpness, contrast, etc. This file format is for viewing and processing with our own software. You may not be able to open or process these files with other graphics software applications, and these files cannot be selected for DPOF printing. RAW files are assigned an orf file extension (\*.orf).

**S (Shutter Priority) Mode**

Also called Shutter Priority AE mode. The user selects the shutter speed and the camera automatically varies the aperture so that the picture is taken with the best exposure.

**Single-lens reflex camera**

A camera that uses a mirror to reflect the light entering from the shooting lens so the image can be checked in the viewfinder. There is no difference between the composition to be captured and the composition viewed on the viewfinder.

**Sleep Mode**

A mode designed to save battery life. The camera automatically enters the sleep mode if you do not operate it for a certain time. To get out of the sleep mode, use any button on the camera (shutter button, menu button, etc.).

**Spot metering**

The meter reading is taken from a very small area around the center of the subject, defined by the spot metering area mark in the viewfinder. Spot metering is ideal for use in difficult light conditions, or when the important element of the picture (subject's face) is small. Use spot metering for backlit subjects, or sports and stage performers. See also digital ESP metering and center weighted averaging metering.

**TFT (Thin-Film Transistor) Color Monitor**

A color monitor constructed using thin-film technology.

**TTL phase-contrast detection system**

This is used to measure the distance to the subject. The camera determines if the image is focused by the detected phase contrast.

**TTL (Through-The-Lens) System**

To help adjust exposure, a light receptor built into the camera directly measures the light passing through the lens.

# Specifications

## Camera specifications

### ■ Product type

Product type	: Single-lens reflex digital camera with interchangeable lens system
Lens	: Zuiko Digital, Four Thirds System Lens
Lens mount	: Four Thirds mount
Equivalent focal length on a 35 mm film camera	: Approx. twice the focal length of the lens

### ■ Image pickup device

Product type	: 4/3" Live MOS sensor
No. of total pixels	: Approx. 11,800,000 pixels
No. of effective pixels	: Approx. 10,000,000 pixels
Screen size	: 17.3 mm (H) x 13.0 mm (V) (0.7" x 0.5")
Aspect ratio	: 1.33 (4:3)

### ■ Viewfinder

Product type	: Eye-level single-lens reflex viewfinder
Field of view	: Approx. 95 % (for field of view on recorded images)
Viewfinder magnification	: Approx. 0.92x ( $-1 \text{ m}^{-1}$ , 50 mm lens, infinity)
Eye point	: Approx. 14 mm (0.6") from the cover glass ( $-1 \text{ m}^{-1}$ )
Diopter adjustment range	: $-3.0 - +1.0 \text{ m}^{-1}$
Optical path fraction	: Quick return half mirror
Depth of field	: When PREVIEW registered with the  button
Focusing screen	: Fixed
Eyecup	: Interchangeable

### ■ Live view

	: Uses Live MOS sensor for shooting
	: Field of view of 100 %

### ■ LCD monitor

Product type	: 2.7" TFT color LCD
Total no. of pixels	: Approx. 230,000 dots

### ■ Shutter

Product type	: Computerized focal-plane shutter
Shutter	: 1/4000 – 60 sec., Bulb shooting

### ■ Auto focus

Product type	: TTL phase-contrast detection system / Imager contrast detection system
Focusing points	: 3-point multiple AF (left, center, right) 11-point multiple AF: with <b>[IMAGER AF]</b>
AF luminance range	: EV 0 – EV 19 (ISO 100 equivalent, at room temperature 20 °C (68 °F), TTL phase-contrast detection system)
Selection of focusing point	: Auto, Optional
AF illuminator	: The built-in flash provides light.

### ■ Exposure control

Metering system	: TTL full-aperture metering system (1) Digital ESP metering (2) Center weighted averaging metering (3) Spot metering (approx. 2 % for the viewfinder screen)
Metering range	: EV 1 – 20 (Digital ESP metering, Center weighted average metering, Spot metering) (At room temperature, 50 mm f2.0, ISO 100)

Shooting modes	: (1) <b>AUTO</b> : Fully automatic (2) <b>P</b> : Program AE (Program shift can be performed) (3) <b>A</b> : Aperture priority AE (4) <b>S</b> : Shutter priority AE (5) <b>M</b> : Manual
ISO sensitivity	: 100 – 1600
Exposure compensation	: ±5 EV (1/3 EV step)
<b>■ White balance</b>	
Product type	: Image pickup device
Mode setting	: Auto, Preset WB (8 settings), Customized WB, One-touch WB
<b>■ Recording</b>	
Memory	: CF card (Compatible with Type I and II) Microdrive (Compatible with FAT 16 / 32) xD-Picture Card
Recording system	: Digital recording, JPEG (in accordance with Design rule for Camera File system [DCF]), RAW Data
Applicable standards	: Exif 2.2, Digital Print Order Format (DPOF), PRINT Image Matching III, PictBridge
<b>■ Playback</b>	
Playback mode	: Single-frame playback, Close-up playback, Index display, Image rotation, Slideshow, Calendar display
Information display	: Information display, Histogram display
<b>■ Drive</b>	
Drive mode	: Single-frame shooting, Sequential shooting, Self-timer, Remote control
Sequential shooting	: 3.5 frames / sec. (Max. no. of storable sequential pictures: 8 frames in RAW)
Self-timer	: Operation time: 12 sec., 2 sec.
Optical remote control	: Operation time: 2 sec., 0 sec. (instantaneous shooting) (RM-1 Remote Control [optional])
<b>■ Flash</b>	
Synchronization	: Synchronized with the camera at 1/180 sec. or less
Flash control mode	: TTL-AUTO (TTL pre-flash mode), AUTO, MANUAL
External flash attachment	: Hot shoe
Wireless flash function	: Compatible with the Olympus wireless RC flash system
<b>■ External connector</b>	
USB connector, VIDEO OUT connector (Multi-connector)	
<b>■ Power supply</b>	
Battery	: Li-ion Battery (BLS-1) x1
<b>■ Dimensions / weight</b>	
Dimensions	: 129.5 mm (W) x 91 mm (H) x 53 mm (D) (5.1" x 3.6" x 2.1") (excluding protrusions)
Weight	: Approx. 380 g (0.8 lb.) (without battery)
<b>■ Operating environment</b>	
Temperature	: 0 °C – 40 °C (32 °F – 104 °F) (operation) / –20 °C – 60 °C (–4 °F – 140 °F) (storage)
Humidity	: 30 – 90 % (operation) / 10 – 90 % (storage)

## Battery / charger specifications

### BLS-1 Lithium ion battery

---

MODEL NO.	: PS-BLS1
Product type	: Rechargeable Lithium ion battery
Nominal voltage	: DC 7.2 V
Nominal capacity	: 1150 mAh
No. of charge and discharge times	: Approx. 500 times (vary with usage conditions)
Ambient temperature	: 0 °C – 40 °C (32 °F – 104 °F) (charging) -10 °C – 60 °C (14 °F – 140 °F) (operation) -20 °C – 35 °C (-4 °F – 95 °F) (storage)
Dimensions	: Approx. 35.5 mm (W) x 55 mm (D) x 12.8 mm (H) (1.4" x 2.2" x 0.5")
Weight	: Approx. 46 g (0.1 lb.)

### BCS-1 Lithium ion charger

---

MODEL NO.	: PS-BCS1
Rated input	: U.S.A CANADA AC 120 V (60 Hz) Other countries AC 100 V – 240 V (50 / 60 Hz)
Rated output	: DC 8.35 V, 400 mA
Charging time	: Approx. 3 hours 30 minutes. (room temperature: if using BLS-1)
Ambient temperature	: 0 °C – 40 °C (32 °F – 104 °F) (operation) / -20 °C – 60 °C (-4 °F – 140 °F) (storage)
Dimensions	: Approx. 62 mm (W) x 83 mm (D) x 38 mm (H) (2.4" x 3.3" x 1.5")
Weight	: Approx. 72 g (0.2 lb.) (without AC cable)

**SPECIFICATIONS ARE SUBJECT TO CHANGE WITHOUT ANY NOTICE OR OBLIGATION ON THE PART OF THE MANUFACTURER.**

# E-System Chart

**420**



## Standard Lens



**ZUIKO DIGITAL**  
ED 14-42mm 1:3.5-5.6  
Standard Zoom

Compatible with <b>EX-25*</b> Extension Tube only at 25-42mm	<b>EC-14/</b> <b>EC-20*</b> Tele Converter
---	---



**ZUIKO DIGITAL**  
17.5-45mm 1:3.5-5.6  
Standard Zoom (only  
available in special kit)

Compatible with <b>EX-25*</b> Extension Tube only at 28-45mm	<b>EC-14/</b> <b>EC-20*</b> Tele Converter
---	---

**TF-22**  
Twin Flash  
with adapter ring 52mm  
to 67mm/72mm



**ZUIKO DIGITAL**  
ED 18-180mm 1:3.5-6.3  
Super Zoom (10x)

Compatible with <b>EX-25*</b> Extension Tube only at 50-180mm	<b>EC-14/</b> <b>EC-20*</b> Tele Converter
--	---

**TF-22**  
Twin Flash  
with adapter ring 62mm  
to 67mm/72mm



**ZUIKO DIGITAL**  
ED 40-150mm 1:4.0-5.6  
Telephoto Zoom

Compatible with <b>EX-25*</b> Extension Tube	<b>EC-14/</b> <b>EC-20*</b> Tele Converter
---	---

## Standard Lens



**ZUIKO DIGITAL**  
ED 70-300mm 1:4.0-5.6  
Super Telephoto Zoom

Compatible with <b>EX-25*</b> Extension Tube	<b>EC-14/EC-20*</b> Tele Converter
---	--



**ZUIKO DIGITAL**  
25mm 1:2.8 Pancake  
Standard Lens

Compatible with <b>EX-25*</b> Extension Tube	<b>EC-14/EC-20</b> Tele Converter
---	---



**ZUIKO DIGITAL**  
35mm 1:3.5  
Macro Lens

Compatible with <b>EX-25*</b> Extension Tube	<b>EC-14**/EC-20*</b> Tele Converter ≈25cm
<b>RF-11</b> Ring Flash with FR-1	<b>TF-22</b> Twin Flash with FR-1

## Pro Lens



**ZUIKO DIGITAL**  
11-22mm 1:2.8-3.5  
Wide Zoom

Compatible with <b>EC-14/EC-20**</b> Tele Converter	<b>TF-22</b> Twin Flash
--	-------------------------------



**ZUIKO DIGITAL**  
ED 12-60mm 1:2.8-4.0  
SWD Standard Zoom

Compatible with <b>EX-25*</b> Extension Tube	<b>EC-14/EC-20*</b> Tele Converter only at 60mm
---	--

## Pro Lens



**ZUIKO DIGITAL**  
ED 14-54mm 1:2.8-3.5  
Standard Zoom

Compatible with <b>EX-25*</b> Extension Tube only at 54mm	<b>EC-14/EC-20**</b> Tele Converter
<b>RF-11</b> Ring Flash	<b>TF-22</b> Twin Flash



**ZUIKO DIGITAL**  
ED 50-200mm 1:2.8-3.5  
SWD Telephoto Zoom

Compatible with <b>EX-25*</b> Extension Tube	<b>EC-14/EC-20**</b> Tele Converter
<b>RF-11</b> Ring Flash	<b>TF-22</b> Twin Flash



**ZUIKO DIGITAL**  
ED 8mm 1:3.5  
Fisheye Lens

Compatible with <b>EC-14/EC-20*</b> Tele Converter
---



**ZUIKO DIGITAL**  
ED 50mm 1:2.0  
Macro Lens

Compatible with <b>EX-25*</b> Extension Tube Converter	<b>EC-14/EC-20</b> Tele Converter
<b>RF-11</b> Ring Flash with FR-1	<b>TF-22</b> Twin Flash with FR-1

## Top Pro Lens



**ZUIKO DIGITAL**  
ED 7-14mm 1:4.0  
Wide Zoom

Compatible with <b>EC-14/EC-20*</b> Tele Converter
---

Information

## Top Pro Lens



**ZUIKO DIGITAL**  
ED 14-35mm 1:2.0 SWD  
Standard Zoom

Compatible with <b>EC-14/EC-20</b> Tele Converter
--



**ZUIKO DIGITAL**  
ED 35-100mm 1:2.0  
Telephoto Zoom

Compatible with <b>EX-25*</b> Extension Tube only at 60-100mm	<b>EC-14/EC-20</b> Tele Converter
--	---



**ZUIKO DIGITAL**  
ED 90-250mm 1:2.8  
Telephoto Zoom

Compatible with <b>EX-25*</b> Extension Tube	<b>EC-14/EC-20</b> Tele Converter
---	---



**ZUIKO DIGITAL**  
ED 150mm 1:2.0  
Fix Focal Lens

Compatible with <b>EX-25*</b> Extension Tube	<b>EC-14/EC-20</b> Tele Converter
---	---



**ZUIKO DIGITAL**  
ED 300mm 1:2.8  
Fix Focal Lens

Compatible with <b>EX-25*</b> Extension Tube	<b>EC-14/EC-20</b> Tele Converter
---	---

Drop-in Filter Set included



## Adapter



**ZUIKO DIGITAL**  
1.4x Teleconverter  
EC-14



**ZUIKO DIGITAL**  
2.0x Teleconverter  
EC-20



**EX-25**  
Extension Tube



**MF-1**  
OM-Adapter

## Remote control



**RM-1**  
Remote Control



**RM-UC1**  
Remote Cable

## Flash

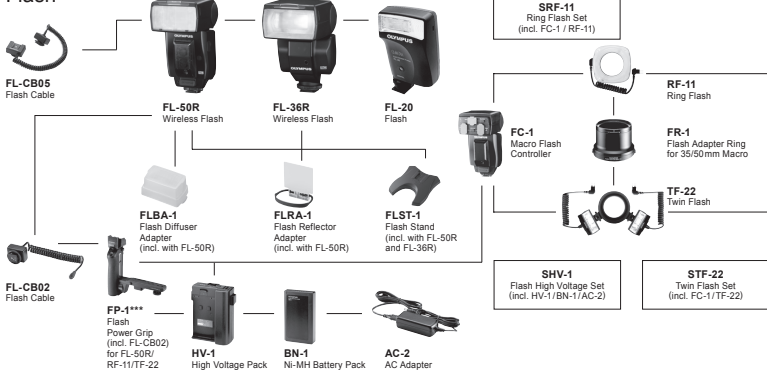

## Power Supply



**BLS-1**  
Li-Ion Battery Pack  
(for E-420)



**BCS-1**  
Li-Ion Battery  
Charger

## Leather Shoulder Strap



**CSS-S101L**  
Black



**CSS-S102L**  
White



**CSS-S103L**  
Brown



**CSS-S104L**  
Darkbrown

## E-System Bags



E-System Bag



E-System Bag



E-System Backpack



E-System Double  
Zoom Kit Bag



E-System Bag Compact



E-400 Series  
Leather Bag

## E-420 Leather Bag



Black



Brown



White

For ZUIKO DIGITAL ED 14-42mm or ZUIKO DIGITAL ED 40-150mm



Black



Brown



White

For ZUIKO DIGITAL ED 25mm Pancake

## Eyecups



**DE-P3**  
Eyecup  
Diopter +3



**DE-N3**  
Eyecup  
Diopter -3



**EP-5**  
Eyecup  
(Standard)



**EP-6**  
Eyecup



**EP-7**  
Eyecup  
incl. with E-3



**ME-1**  
Magnifier  
Eyecup



**VA-1**  
Angle Finder

\*Only with MF \*\*AF possible when using center frame \*\*\*Only with FR-1

Specifications and appearances are subject to change without any notice or obligation on the part of the manufacturer.

## SAFETY PRECAUTIONS



**CAUTION**  
RISK OF ELECTRIC SHOCK  
DO NOT OPEN



**CAUTION:** TO REDUCE THE RISK OF ELECTRICAL SHOCK, DO NOT REMOVE COVER (OR BACK). NO USER-SERVICEABLE PARTS INSIDE. REFER SERVICING TO QUALIFIED OLYMPUS SERVICE PERSONNEL.



An exclamation mark enclosed in a triangle alerts you to important operating and maintenance instructions in the documentation provided with the product.



### **DANGER**

If the product is used without observing the information given under this symbol, serious injury or death may result.



### **WARNING**

If the product is used without observing the information given under this symbol, injury or death may result.



### **CAUTION**

If the product is used without observing the information given under this symbol, minor personal injury, damage to the equipment, or loss of valuable data may result.

### **WARNING!**

**TO AVOID THE RISK OF FIRE OR ELECTRICAL SHOCK, NEVER DISASSEMBLE, EXPOSE THIS PRODUCT TO WATER OR OPERATE IN A HIGH HUMIDITY ENVIRONMENT.**

## General Precautions

**Read All Instructions** – Before you use the product, read all operating instructions. Save all manuals and documentation for future reference.

**Cleaning** – Always unplug this product from the wall outlet before cleaning. Use only a damp cloth for cleaning. Never use any type of liquid or aerosol cleaner, or any type of organic solvent to clean this product.

**Attachments** – For your safety, and to avoid damaging the product, use only accessories recommended by Olympus.

**Water and Moisture** – For precautions on products with weatherproof designs, read the weatherproofing sections.

**Location** – To avoid damage to the product, mount the product securely on a stable tripod, stand, or bracket.

**Power Source** – Connect this product only to the power source described on the product label.

**Foreign Objects** – To avoid personal injury, never insert a metal object into the product.

**Heat** – Never use or store this product near any heat source such as a radiator, heat register, stove, or any type of equipment or appliance that generates heat, including stereo amplifiers.

## Product Handling Precautions



### WARNING

- Do not use the camera near flammable or explosive gases.
- Do not use the flash and LED on people (infants, small children, etc.) at close range.
  - You must be at least 1 m (3 ft.) away from the faces of your subjects. Firing the flash too close to the subject's eyes could cause a momentary loss of vision.
- Keep young children and infants away from the camera.
  - Always use and store the camera out of the reach of young children and infants to prevent the following dangerous situations which could cause serious injury:
    - Becoming entangled in the camera strap, causing strangulation.
    - Accidentally swallowing the battery, cards or other small parts.
    - Accidentally firing the flash into their own eyes or those of another child.
    - Accidentally being injured by the moving parts of the camera.
- Do not look at the sun or strong lights with the camera.
- Do not use or store the camera in dusty or humid places.
- Do not cover the flash with a hand while firing.



### CAUTION

- Stop using the camera immediately if you notice any unusual odors, noise, or smoke around it.
  - Never remove the batteries with bare hands, which may cause a fire or burn your hands.
- Never hold or operate the camera with wet hands.
- Do not leave the camera in places where it may be subject to extremely high temperatures.
  - Doing so may cause parts to deteriorate and, in some circumstances, cause the camera to catch fire. Do not use the charger if it is covered (such as a blanket). This could cause overheating, resulting in fire.
- Handle the camera with care to avoid getting a low-temperature burn.
  - When the camera contains metal parts, overheating can result in a low-temperature burn. Pay attention to the following:
    - When used for a long period, the camera will get hot. If you hold on to the camera in this state, a low-temperature burn may be caused.
    - In places subject to extremely cold temperatures, the temperature of the camera's body may be lower than the environmental temperature. If possible, wear gloves when handling the camera in cold temperatures.
- Be careful with the strap.
  - Be careful with the strap when you carry the camera. It could easily catch on stray objects – and cause serious damage.

## Battery Handling Precautions

Follow these important guidelines to prevent batteries from leaking, overheating, burning, exploding, or causing electrical shocks or burns.



### DANGER

- The camera uses a lithium ion battery specified by Olympus. Charge the battery with the specified charger. Do not use any other chargers.
- Never heat or incinerate batteries.
- Take precautions when carrying or storing batteries to prevent them from coming into contact with any metal objects such as jewelry, pins, fasteners, etc.
- Never store batteries where they will be exposed to direct sunlight, or subjected to high temperatures in a hot vehicle, near a heat source, etc.
- To prevent causing battery leaks or damaging their terminals, carefully follow all instructions regarding the use of batteries. Never attempt to disassemble a battery or modify it in any way, by soldering, etc.
- If battery fluid gets into your eyes, flush your eyes immediately with clear, cold running water and seek medical attention immediately.
- Always store batteries out of the reach of small children. If a child accidentally swallows a battery, seek medical attention immediately.



## WARNING

- Keep batteries dry at all times.
- To prevent batteries from leaking, overheating, or causing a fire or explosion, use only batteries recommended for use with this product.
- Insert the battery carefully as described in the operating instructions.
- If rechargeable batteries have not been recharged within the specified time, stop charging them and do not use them.
- Do not use a battery if it is cracked or broken.
- If a battery leaks, becomes discolored or deformed, or becomes abnormal in any other way during operation, stop using the camera.
- If a battery leaks fluid onto your clothing or skin, remove the clothing and flush the affected area with clean, running cold water immediately. If the fluid burns your skin, seek medical attention immediately.
- Never subject batteries to strong shocks or continuous vibration.



## CAUTION

- Before loading, always inspect the battery carefully for leaks, discoloration, warping, or any other abnormality.
- The battery may become hot during prolonged use. To avoid minor burns, do not remove it immediately after using the camera.
- Always unload the battery from the camera before storing the camera for a long period.
- This camera uses a lithium ion battery specified by Olympus. Do not use any other type of battery. For safe and proper use, read the battery's instruction manual carefully before using it.
- If the battery's terminals get wet or greasy, camera contact failure may result. Wipe the battery well with a dry cloth before use.
- Always charge a battery when using it for the first time, or if it has not been used for a long period.
- When operating the camera with battery power at low temperatures, try to keep the camera and spare battery as warm as possible. A battery that has run down at low temperatures may be restored after it is warmed at room temperature.
- The number of pictures you can take may vary depending on the shooting conditions or battery.
- Before going on a long trip, and especially before traveling abroad, purchase extra batteries. A recommended battery may be difficult to obtain while traveling.
- Please recycle batteries to help save our planet's resources. When you throw away dead batteries, be sure to cover their terminals and always observe local laws and regulations.

## Caution for Usage Environment

- To protect the high-precision technology contained in this product, never leave the camera in the places listed below, no matter if in use or storage:
  - Places where temperatures and / or humidity are high or go through extreme changes. Direct sunlight, beaches, locked cars, or near other heat sources (stove, radiator, etc.) or humidifiers.
  - In sandy or dusty environments.
  - Near flammable items or explosives.
  - In wet places, such as bathrooms or in the rain. When using products with weatherproof designs, read their manuals as well.
  - In places prone to strong vibrations.
- Never drop the camera or subject it to severe shocks or vibrations.
- When mounted on a tripod, adjust the position of the camera with the tripod head. Do not twist the camera.
- Do not leave the camera pointed directly at the sun. This may cause lens or shutter curtain damage, color failure, ghosting on the image pickup device, or may possibly cause fires.
- Do not touch electric contacts on cameras and interchangeable lenses. Remember to attach the body cap when removing the lens.
- Before storing the camera for a long period, remove the battery. Select a cool, dry location for storage to prevent condensation or mold from forming inside the camera. After storage, test the camera by turning it on and pressing the shutter release button to make sure that it is operating normally.
- Always observe the operating environment restrictions described in the camera's manual.

## LCD Monitor

- Do not push the monitor forcibly; otherwise the image may become vague, resulting in a playback mode failure or damage to the monitor.
- A strip of light may appear on the top / bottom of the monitor, but this is not a malfunction.
- When a subject is viewed diagonally in the camera, the edges may appear zigzagged on the monitor. This is not a malfunction; it will be less noticeable in playback mode.
- In places subject to low temperatures, the LCD monitor may take a long time to turn on or its color may change temporarily. When using the camera in extremely cold places, it is a good idea to occasionally place it in a warm place. An LCD monitor exhibiting poor performance due to low temperatures will recover in normal temperatures.
- The LCD used for the monitor is made with high-precision technology. However, black spots or bright spots of light may appear constantly on the LCD Monitor. Due to its characteristics or the angle at which you are viewing the monitor, the spot may not be uniform in color and brightness. This is not a malfunction.

## Lens

- Do not immerse in water or splash with water.
- Do not drop or exert strong force on the lens.
- Do not hold at the moving part of the lens.
- Do not touch the lens surface directly.
- Do not touch the contact points directly.
- Do not subject to abrupt temperature changes.
- The operating temperature range is  $-10^{\circ}\text{C} - 40^{\circ}\text{C}$  ( $14^{\circ}\text{F} - 104^{\circ}\text{F}$ ). Always use within this temperature range.

## Legal and Other Notices

- Olympus makes no representations or warranties regarding any damages, or benefit expected by using this unit lawfully, or any request from a third person, which are caused by the inappropriate use of this product.
- Olympus makes no representations or warranties regarding any damages or any benefit expected by using this unit lawfully which are caused by erasing picture data.

## Disclaimer of Warranty

- Olympus makes no representations or warranties, either expressed or implied, by or concerning any content of these written materials or software, and in no event shall be liable for any implied warranty of merchantability or fitness for any particular purpose or for any consequential, incidental or indirect damages (including but not limited to damages for loss of business profits, business interruption and loss of business information) arising from the use or inability to use these written materials or software or equipment. Some countries do not allow the exclusion or limitation of liability for consequential or incidental damages, so the above limitations may not apply to you.
- Olympus reserves all rights to this manual.

## Warning

Unauthorized photographing or use of copyrighted material may violate applicable copyright laws. Olympus assumes no responsibility for unauthorized photographing, use or other acts that infringe upon the rights of copyright owners.

## Copyright Notice

All rights reserved. No part of these written materials or this software may be reproduced or used in any form or by any means, electronic or mechanical, including photocopying and recording or the use of any type of information storage and retrieval system, without the prior written permission of Olympus. No liability is assumed with respect to the use of the information contained in these written materials or software, or for damages resulting from the use of the information contained therein. Olympus reserves the right to alter the features and contents of this publication or software without obligation or advance notice.

## FCC Notice

### • Radio and Television Interference

Changes or modifications not expressly approved by the manufacturer may void the user's authority to operate this equipment. This equipment has been tested and found to comply with the limits for a Class B digital device, pursuant to Part 15 of the FCC Rules. These limits are designed to provide reasonable protection against harmful interference in a residential installation.

This equipment generates, uses, and can radiate radio frequency energy and, if not installed and used in accordance with the instructions, may cause harmful interference to radio communications.

However, there is no guarantee that interference will not occur in a particular installation. If this equipment does cause harmful interference to radio or television reception, which can be determined by turning the equipment off and on, the user is encouraged to try to correct the interference by one or more of the following measures:

- Adjust or relocate the receiving antenna.
- Increase the distance between the camera and receiver.
- Connect the equipment to an outlet on a circuit different from that to which the receiver is connected.
- Consult your dealer or an experienced radio / TV technician for help. Only the OLYMPUS-supplied USB cable should be used to connect the camera to USB enabled personal computers (PC).

Any unauthorized changes or modifications to this equipment would void the user's authority to operate it.

## Use Only Dedicated Rechargeable Battery and Battery Charger

We strongly recommend that you use only the genuine Olympus dedicated rechargeable battery and battery charger with this camera.

Using a non-genuine rechargeable battery and / or battery charger may result in fire or personal injury due to leakage, heating, ignition or damage to the battery. Olympus does not assume any liability for accidents or damage that may result from the use of a battery and / or battery charger that are not genuine Olympus accessories.

## For customers in North and South America

### For customers in USA

Declaration of Conformity

Model Number : E-420

Trade Name : OLYMPUS

Responsible Party : **OLYMPUS IMAGING AMERICA INC.**

Address : 3500 Corporate Parkway, P.O. Box 610, Center Valley,  
PA 18034-0610, USA

Telephone Number: 484-896-5000

Tested To Comply With FCC Standards

FOR HOME OR OFFICE USE

This device complies with Part 15 of the FCC rules.

Operation is subject to the following two conditions:

- (1) This device may not cause harmful interference.
- (2) This device must accept any interference received, including interference that may cause undesired operation.

### For customers in Canada

This Class B digital apparatus meets all requirements of the Canadian Interference-Causing Equipment Regulations.

## For customers in Europe



"CE" mark indicates that this product complies with the European requirements for safety, health, environment and customer protection. "CE" mark cameras are intended for sales in Europe.



This symbol [crossed-out wheeled bin WEEE Annex IV] indicates separate collection of waste electrical and electronic equipment in the EU countries.  
Please do not throw the equipment into the domestic refuse.  
Please use the return and collection systems available in your country for the disposal of this product.

### Provisions of warranty

1. If this product proves to be defective, although it has been used properly (in accordance with the written Handling Care and Operating instructions supplied with it), during a period of two years from the date of purchase from an authorized Olympus distributor within the business area of Olympus Imaging Europa GmbH as stipulated on the website: <http://www.olympus.com> this product will be repaired, or at Olympus's option replaced, free of charge. To claim under this warranty the customer must take the product and this Warranty Certificate before the end of the two year warranty period to the dealer where the product was purchased or any other Olympus service station within the business area of Olympus Imaging Europa GmbH as stipulated on the website: <http://www.olympus.com>. During the one year period of the World Wide Warranty the customer may turn the product in at any Olympus service station. Please notice that not in all countries such Olympus service station exists.
2. The customer shall transport the product to the dealer or Olympus authorized service station at his own risk and shall be responsible for any costs incurred in transporting the product.
3. This warranty does not cover the following and the customer will be required to pay repair charge, even for defects occurring within the warranty period referred to above.
  - (a) Any defect that occurs due to mishandling (such as an operation performed that is not mentioned in the Handling Care or other sections of the instructions, etc.).
  - (b) Any defect that occurs due to repair, modification, cleaning, etc. performed by anyone other than Olympus or an Olympus authorized service station.
  - (c) Any defect or damage that occurs due to transport, a fall, shock, etc. after purchase of the product.
  - (d) Any defect or damage that occurs due to fire, earthquake, flood damage, thunderbolt, other natural disasters, environmental pollution and irregular voltage sources.
  - (e) Any defect that occurs due to careless or improper storage (such as keeping the product under conditions of high temperature and humidity, near insect repellents such as naphthalene or harmful drugs, etc.), improper maintenance, etc.
  - (f) Any defect that occurs due to exhausted batteries, etc.
  - (g) Any defect that occurs due to sand, mud, etc. entering the inside of the product casing.
  - (h) When this Warranty Certificate is not returned with the product.
  - (i) When any alterations whatsoever are made to the Warranty Certificate regarding the year, month and date of purchase, the customer's name, the dealer's name, and the serial number.
  - (j) When proof of purchase is not presented with this Warranty Certificate.
4. This Warranty applies to the product only; the Warranty does not apply to any other accessory equipment, such as the case, strap, lens cap and batteries.
5. Olympus's sole liability under this warranty shall be limited to repairing or replacing the product. Any liability for indirect or consequential loss or damage of any kind incurred or suffered by the customer due to a defect of the product, and in particular any loss or damage caused to any lenses, films, other equipment or accessories used with the product or for any loss resulting from a delay in repair or loss of data, is excluded. Compelling regulations by law remain unaffected by this.

## Notes regarding warranty maintenance

1. This warranty will only be valid if the Warranty Certificate is duly completed by Olympus or an authorized dealer or other documents contain sufficient proof. Therefore, please make sure that your name, the name of the dealer, the serial number and the year, month and date of purchase are all completed or the original invoice or the sales receipt (indicating the dealer's name, the date of purchase and product type) is attached to this Warranty Certificate. Olympus reserves the right to refuse free-of-charge service if neither Warranty Certificate is completed nor the above document is attached or if the information contained in it is incomplete or illegible.
  2. Since this Warranty Certificate will not be re-issued, keep it in a safe place.
- Please refer to the list on the web site: <http://www.olympus.com> for the authorized international Olympus service network.

## Trademarks

- IBM is a registered trademark of International Business Machines Corporation.
- Microsoft and Windows are registered trademarks of Microsoft Corporation.
- Macintosh is a trademark of Apple Inc.
- xD-Picture Card™ is a trademark.
- "Shadow Adjustment Technology" function contains patented technologies from Apical Limited.



- All other company and product names are registered trademarks and / or trademarks of their respective owners.
- The standards for camera file systems referred to in this manual are the "Design Rule for Camera File System / DCF" standards stipulated by the Japan Electronics and Information Technology Industries Association (JEITA).



## Symbols

	92
	90
	95
	91
	128
	129
	91
	90
	90
	90
	128
	76
	93
	127
	127
	87
	88
	90
	92
	92
	93
	94
	117
	67
	67
	67
	67

## A

Adobe RGB	93
AE BKT	53
AE bracketing	52
AE lock	52
AEL / AFL	89
AEL / AFL MEMO	89
AEL Metering	92
AF AREA	56, 90
AF ILLUMINAT.	87
AF MODE	54, 90
AF SENSOR	40
AF target	56
ALL	93
ALL ERASE	86
ANTI-SHOCK	61
Aperture priority shooting <b>A</b>	46
Aperture value	46
Auto flash AUTO	70
Auto focus	57, 109
AUTO POP UP	92
AUTO shooting <b>AUTO</b>	4
Auto white balance	64, 65

## B

B (Basic)	62, 112
B&W FILTER	67
BACKLIT LCD	91
Battery	11, 119
BEACH & SNOW	5
BLACK & WHITE	83
BULB FOCUSING	87
Bulb shooting	49, 61
BULB TIMER	92







## C

C-AF (continuous AF)	55
C-AF+MF	56
Calendar display	79
CANDLE	5
CARD SETUP	86, 119
Cards	13, 118
Center weighted averaging metering	50
CF / xD	94
CHILDREN	5
CLEANING MODE	117
Close-up playback	78
COLOR SPACE	93
Color temperature	125
CompactFlash	13, 118
Comparison screen	49
Compression rate	62
Continuous AF (C-AF)	55
CONTRAST	67
CONTROL	91
COPY ALL	84
Custom printing	100
CUSTOM RESET	30
Custom white balance CWB	64

## D



Date / time setting	15
DIAL DIRECTION	88
DIAL FUNCTION	88
Digital ESP metering	50
Diopter adjustment	14
Direct buttons	27
Direct print	98
DIS MODE	5
DOCUMENTS	5
dpi SETTING	94
DPOF	96
Dust reduction	14, 116

<b>E</b>	
Easy printing .....	99
Easy shooting modes .....	4
Enlarged display .....	43
Exposure compensation  .....	51
Eye-piece cover .....	59



<b>F</b>	
F (Fine) .....	62, 112
FACE DETECT  .....	41, 91
FILE NAME .....	94
Fill-in flash  .....	71
FIREWORKS  .....	5
FIRMWARE .....	95
Flash intensity control  .....	74
Flash mode  .....	70
Flash off  .....	71
Fn FACE DETECT .....	41, 91
Focus lock .....	57
FOCUS RING .....	87
FORMAT .....	118
Four Thirds system lenses .....	119
FRAME ASSIST .....	92

<b>G</b>	
GRADATION .....	68



<b>H</b>	
HIGH KEY .....	68
Histogram .....	42, 80, 113
HYBRID AF  .....	40



<b>I</b>	
IMAGER AF  .....	40
Index display  .....	79
Information display .....	42, 80
ISO .....	53, 90
ISO-AUTO .....	92
ISO-AUTO SET .....	92

<b>J</b>	
JPEG EDIT .....	82



<b>L</b>	
 (Large) .....	62, 112
LANDSCAPE  .....	5
LANDSCAPE+PORTRAIT  .....	5
Lens .....	12, 119
Lithium ion battery .....	11, 119

Lithium ion charger .....	11, 119
LIVE PREVIEW .....	49, 90
Live view .....	39
LIVE VIEW AF MODE .....	41
LIVE VIEW BOOST .....	91
LOW KEY .....	68





<b>M</b>	
 (Middle) .....	62, 112
MACRO  .....	5
Manual flash .....	72
Manual focus (MF) .....	42, 55
Manual shooting <b>M</b> .....	48
Menu .....	30
METERING .....	50, 90
MF (manual focus) .....	55
Microdrive .....	13, 118
Monitor adjustment  .....	95
MONOTONE .....	67
MTP .....	91, 107

<b>N</b>	
N (Normal) .....	62, 112
NATURE MACRO  .....	5
NIGHT SCENE  .....	5
NIGHT+PORTRAIT  .....	5
NOISE FILTER .....	69
NOISE REDUCT. ....	69
NTSC .....	95
Number of pixels .....	62















<b>O</b>	
OLYMPUS Master .....	102
Olympus wireless RC flash system .....	76
One-touch white balance  .....	64, 66, 90

<b>P</b>	
PAL .....	95
PANORAMA  .....	5, 44
PICT. TONE .....	67
PictBridge .....	98
PICTURE MODE .....	67
Pixel count .....	62, 93
PIXEL MAPPING .....	117
PORTRAIT  .....	5
Preset white balance .....	64, 65
Preview .....	49, 90
Print mode  .....	100
Print reservation .....	96
Program shift <b>Ps</b> .....	45
Program shooting <b>P</b> .....	45
Protecting <b>On</b> .....	85

## R

RAW .....	63
RAW DATA EDIT .....	82
RAW+JPEG ERASE .....	94
REC VIEW .....	95
Record mode  .....	62, 63, 125
REDEYE FIX .....	83
Red-eye reduction flash  .....	70
Remote control  .....	60
RESET LENS .....	87
RESET PROTECT .....	85
Resizing  .....	83
Rotating images  .....	81

## S

 (Small) .....	62, 112
S-AF (single AF) .....	54
S-AF+MF .....	55
SATURATION .....	67, 83
Scene mode  .....	4
Self-timer  .....	59
SEPIA .....	83
Sequential shooting  .....	58
SF (Super Fine) .....	62, 112
SHADOW ADJ .....	83
SHARPNESS .....	67
Shutter priority shooting <b>S</b> .....	47
Shutter speed .....	45
Single AF (S-AF) .....	54
Single-frame copy .....	84
Single-frame erase  .....	86
Single-frame playback .....	78
Single-frame protect .....	85
Single-frame shooting  .....	58
SLEEP .....	90
Slideshow  .....	81
Slow synchronization  .....	70
Slow synchronization  / 2nd CURTAIN .....	71
SPORT  .....	5
Spot metering – highlight control  .....	50
Spot metering – shadow control  .....	50
Spot metering  .....	50
sRGB .....	93
STORAGE .....	91, 103
Strap .....	10
SUNSET  .....	5
Super control panel .....	7, 28
Super FP flash .....	74

## T

TEST PICTURE .....	90
Trimming  .....	83

## U

USB MODE .....	91
----------------	----

## V

VIDEO OUT .....	95
Viewfinder .....	6, 14, 16

## W

WB .....	65, 90
WB compensation .....	65
White balance <b>WB</b> .....	64

## X

xD-Picture Card .....	13, 118
-----------------------	---------

## Z

ZUIKO DIGITAL interchangeable lens .....	120
--	-----